

Field season 2010

North Greenland Eemian Ice drilling (NEEM) 2007-2012:

NEEM 2nd season of deep ice core drilling and core processing

**Prepared by Ice and Climate Group, NBI
for
The NEEM Steering Committee and Danish and Greenlandic authorities.**



Picture 1: NEEM reaches into the last glacial , 29th July 2009.

**Lars.B.Larsen, Simon G. Sheldon, J.P.Steffensen
Copenhagen, 150310**

Table of Contents

NEEM 2010 introduction	4
NEEM 2007-2012: Season 2010	6
Scientific plan for NEEM 2010.....	10
Logistic plan for NEEM 2010	11
Timeline.	12
Publications and out-reach.....	12
Details on drilling.....	12
Details on science and processing plan.....	13
Important: Sudden changes in manning plan due unforeseen issues.....	15
Shallow ice coring.....	16
Details on strain net.	16
Positions of NEEM camp, NGRIP and 2007-2008 traverse route.	17
List of waypoints	18
Strain net around NEEM site.....	20
Associated project: Earthquake station at NEEM.....	21
NEEM 2010 schedule	22
NEEM Manning 2010	23
Camp population.....	29
The DV and press visit July 20th.....	29
Handling of Waste and environmentally hazardous chemicals.....	30
Fire hazards.....	30
Quartering and buildings	31
Personal field equipment.....	32
SITREP	33
Daily report on the web (www.icecores.dk)	33
NEEM Official Address in Greenland.....	33
Terms of reference for the NEEM 2010 Field Season.....	34
Accidents and Illness.....	34
NEEM 2010 – Useful numbers	35
Iridium OpenPort system.....	36
Personnel Transport 2010.....	37
Booze and Drugs	37
Welcome To The NEEM Camp	38
Personal Locator Beacon (PLB).....	39
Power Supply.....	40
Assigned Duties	41
Maps of the NEEM camp area and layout	42
Skiway Marking:.....	45

NEEM weather conditions 2006 - 2008	46
Status of the Closed NGRIP Camp.....	50
Main Dome (75.0977N, 42.3195W):	50
Former site of The Lucht Kastel:	50
The NGRIP2 Deep Borehole:	50
Kangerlussuaq and Surrounding Area	51
The KISS (Kangerlussuaq International Science Support) facility	53
Thule Air Base	54
Useful Telephone numbers at Thule AB, Duty/Home	55
Cargo shipments to Greenland	57
Shipping to NEEM from the United States/Canada	57
U.S. CUSTOMS INFORMATION - 2009	58
Address of the 109 th :	59
Ship connections to Kangerlussuaq (2009):	59
NEEM Drilling Liquid Properties	60
Shipping boxes	64
Flight and cargo considerations 2009	64
Typical specifications for LC-130 and Twin Otter	65
Typical LC-130 specifications:	66
Useful container data.....	67
CINA equation for the relation between pressure and altitude:	68
Chill temperature:	68
Coordination of LC-130 in Kangerlussuaq.....	70
AVIATION WEATHER REPORTS.....	72
Communication plan	73
Summary of frequencies used in Greenland	74
Phonetic alphabet	75
Positions in Greenland	77
Relevant distances and directions	78
NEEM Steering Committee	79
NEEM 2009 Participant Address List.....	82
Phone numbers	85
MEDICAL.....	88
Sun glasses.....	89
Acute mountain sickness - AMS	89
How to operate the Gamow bag	90
How to monitor blood pressure using the Omron electronic monitor	90
Automated External Defibrillator (AED)	92

NEEM 2010 introduction

In the last 45 years deep ice coring projects have been recurring roughly every ten years. The drilling at Camp Century (1963-1966) was conducted as part of a U.S. Army engineering experiment during the Cold War. When the 1370 m long Camp Century ice core was analysed for stable isotope composition the first ice core based climate record into the last glacial period was revealed in 1969-1972. In the seventies the science community saw much controversy about in particular the very fast “jumps” in the isotope record from the last glacial period.

GISP (Greenland Ice Sheet Program), a collaboration of scientists from the U.S., Switzerland and Denmark, resulted in a 2037 m long deep ice core drilled at Dye-3 in South Greenland (1979-1981). The Dye-3 record confirmed the fast “jumps” from Camp Century as being a result of fast climatic oscillations during the last glacial period. The climate oscillations have later been called “Dansgaard-Oeschger cycles” or “Interstadials”.

To obtain the longest climatic record a deep ice coring was planned at the summit of the Greenland Ice Sheet. Due to political difficulties, the planned drilling was conducted by a European team at the very summit of the ice sheet in 1989-1992 (GRIP, GReenland Ice core Project) and a US team some 30 km West of the summit in 1989-1993 (GISP2) in two parallel drillings. As a result, scientists got two ice core records, GRIP was 3027 m long and GISP2 3065 m long, which could be compared in great detail. Much to the dismay of both ice coring teams, it turned out that although both the GRIP and the GISP2 record contained ice from the previous interglacial, the Eemian, they also had disturbed layer structures in ice older than 80,000 years, well before the Eemian was reached. The old GISP2 site is today the permanent US Summit station.

To obtain an undisturbed record of the early glacial, the Eemian and beyond, NGRIP (North GReenland Ice core Project) was formed as a Danish led international ice drilling project on the ice crest some 300 km NNW of summit. The project started in 1996 and ran in parallel with the two European ice core drillings in Antarctica, the EPICA project. Due to set-backs caused by a lost drill and warm ice at the base, NGRIP did not reach bedrock at 3090 m before 2004. The NGRIP ice core turned out to contain both a curse and a blessing. Due to basal melting caused by geothermal heat, the oldest ice, including the first half of the Eemian. Thus the climate record could only be extended to 125,000 years back in time. On the other hand however, basal melting insured undisturbed stratigraphy along the whole ice core length and insured an unparalleled temporal resolution which has allowed for an annually counted ice core time scale 60,000 years back in time.

With the present discussion about global warming the Eemian period has attracted a lot of attention. In Europe the Eemian was about 5 degrees C warmer than today and sea levels were some 5 m higher. The Eemian serves as a Nature’s parallel to a future with global warming. Therefore NEEM (North Greenland Eemian ice drilling) has as a goal to obtain a complete ice core record from the Eemian for a thorough comparison with our present climate in the Holocene. NEEM is the sixth deep ice coring in Greenland.

The main goal of NEEM in 2010 is to perform deep ice core drilling and core processing with the most comprehensive and advanced ice core analysis equipment ever brought to the field. NEEM 2010 camp will also be a platform for some associated projects: PARCA shallow

coring program, Ice2Sea shallow coring, a seismic station, biological tests and trace substance analysis on shallow cores.

The main transport between NEEM camp and Kangerlussuaq will be by ski equipped LC-130 aeroplanes from the U.S. Air Force, 109th Tactical Air Group, Scotia, N.Y. The planes are provided as part of the logistical contribution to NEEM from the U.S. National Science Foundation.

This report provides the participants with information on the conditions in Kangerlussuaq, Thule AB and the NEEM camp. It includes a summary of all individual travel dates and information on science programs. It also contains information and rules on environmental issues, work safety and disaster preparedness. All participants are assumed to be familiar with the content of this report.

In addition to general information, the report contains reference information of special interest for the Field Operation Managers and Field Leaders.

Copenhagen, March 15th, 2010

Lars Berg Larsen, Simon Sheldon, J.P.Steffensen

NEEM 2007-2012: Season 2010

NEEM 2nd season of deep ice core drilling and core processing

Purpose:

To perform deep ice core drilling and ice core processing at NEEM (pos: N 77 deg. 26 min. 54.93 sec., W 51 deg. 03 min. 19.89 sec. Altitude: 2484 m a.s.l. or 8140 feet).

To provide housing and food for 35 participants during the 110 day field season. To provide working facilities for the most comprehensive ice core analysis program ever performed in the field.

To support associated programs, such as shallow coring, pit studies, experiments with tracer particles, shallow core sampling, strain net measurements and operation of a seismic station.

Background:

The International ice coring community (IPICS) has stated that an ice core drilling through the Greenland ice sheet at NEEM is the most important ice coring project in the Northern Hemisphere in conjunction with the International Polar Year. The NEEM drilling project is part of the recommendations from the international IPY committee and it is part of the proposals adopted by the Danish National IPY Committee.

By December 2006 / January 2007 the NEEM proposal had secured funding from the Danish Government IPY funds (50 %) and the US NSF (30%). With 80% funding secured, international partners were called to Copenhagen for the first NEEM Steering Committee meeting in March 2007. At the meeting representatives from 14 nations expressed interest in participating. Several nations have already secured IPY related funding and other nations have IPY applications in review. At the steering committee meeting it became clear that NEEM would be fully funded. Thus NEEM started its activities in the summer 2007. NEEM is a Danish led international IPY-project. The other participating nations are: Belgium, Canada, China, France, Germany, Holland, Iceland, Japan, South Korea, Sweden, Switzerland, U.K. and USA.

The NEEM site has been selected through analysis of available surface elevation data, ice thickness data and ice radar data as the most promising site on the Greenland Ice Sheet for obtaining an undisturbed ice core record of the Eemian period and the previous glacial. (Fig. 1)

In the summer of 2007 a surface traverse from NGRIP reached NEEM, and after GPS based survey the NEEM site was selected on the local ice divide. A skiway area was laid out with the skiway pointing into the prevailing wind. A "seed" camp was constructed consisting of a 20 by 12 feet weatherport on a small snow hill, two heavy tracked vehicles, three snowmobiles and four heavy sleds with supplies.



Figur 1: One of the two traverse trains enroute from NGRIP to NEEM July 2007.

During the traverse, three ice cores were drilled to 60m, 60 m and 80 m depth, and a surface strainnet was established. The planned surface radar survey was not so successful. The radar failed to collect data of sufficient quality to evaluate the basal conditions at NEEM. This means that we have to rely on the existing information and begin the deep drilling at the site selected.

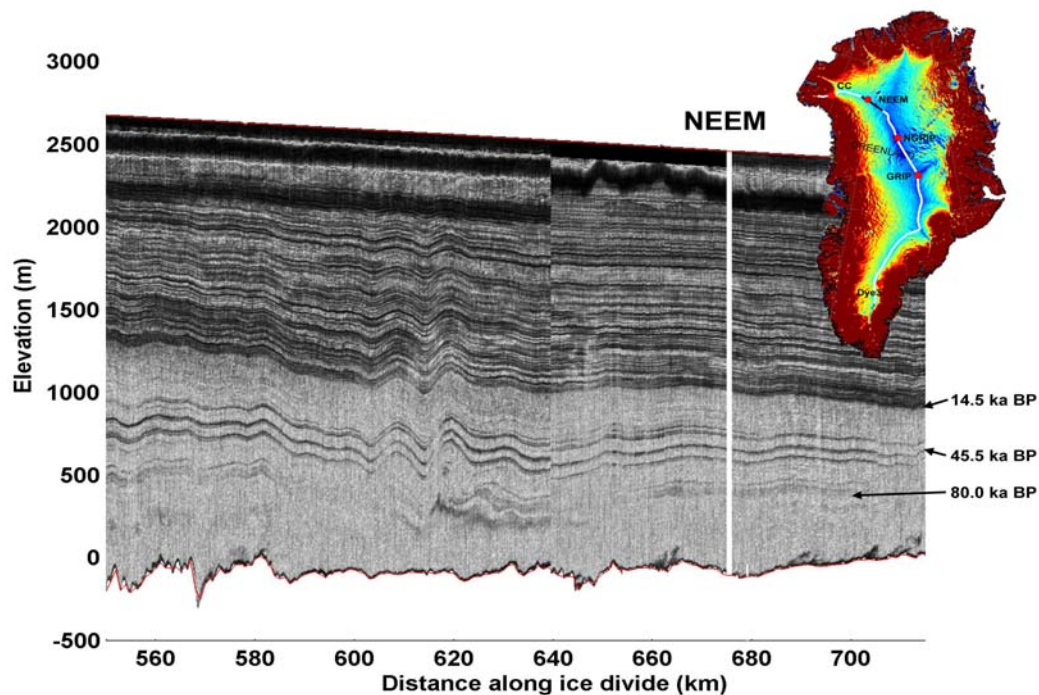
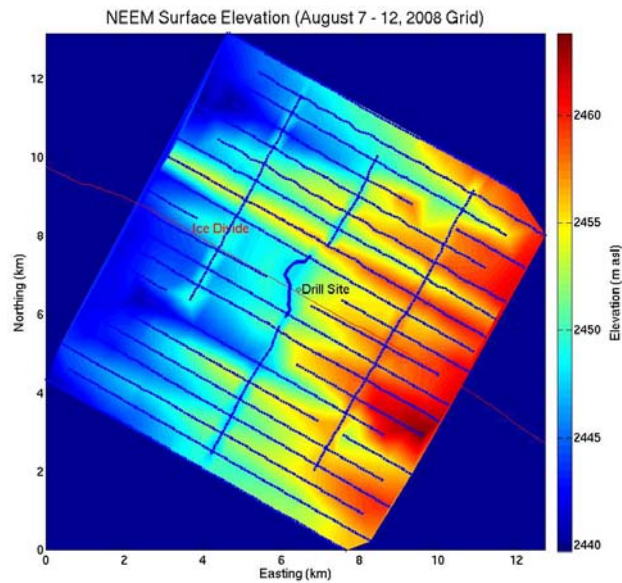

Fig. 1. Analysis of internal radar reflectors (isochrones). The NEEM site is indicated. The map over Greenland shows surface slope of the Ice Sheet (blue: flat and red: steep). The white line shows the ice divide from Dye-3 in the South to Camp Century (CC) in the North West. The radar image covers the black section of the ice divide.

In 2008 the NEEM camp was constructed and the necessary infrastructure was put in place, so that camp in the future will be able to house 35 participants with drill trench and science trench ready for mounting the drill and a functional ice core processing line, after an opening period of two weeks.

A second traverse to NGRIP in 2008 was successful and all assets from NGRIP were brought to NEEM. The CReSiS radar team were successful in surveying a grid around NEEM, and the following maps have been generated.



Data from Claude Laird, CReSiS

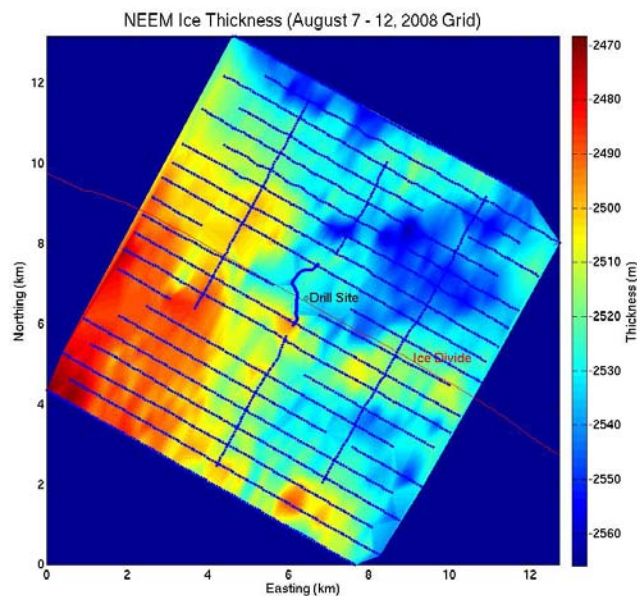

Data from Claude Laird, CReSiS

In the 2009 field season, the constructions of the main dome were finished. The science trench was enlarged to accommodate the warm labs for CFA and physical properties and an elevator and staircase were put in place at the end of the drill trench. Also the whole electrical power system in camp was revised. The NEEM skiway was turned 45 degrees to point into the prevailing wind.

After repairing several units of control panels for the main winch and replacement of the winch motor, drilling began Friday May 15, and by mid June core processing and CFA measurements began. Drilling, core processing and CFA measurements continued through the season, and by mid August, drillers reached 1758 m depth, which is a new one-season record. All drilled core has been logged.

The new drilling fluid turned out to behave better than we had feared. Although wet clothes from splashes and dissolving boots and clothes continue to be a problem, it can be mitigated by protective clothing. The fluid does evaporate from the cores so that after some days in the buffer, the cores are dry, and we have not encountered problems in the processing line.

During the season the processing line worked fine, and ice from 98.45 m to 601.7 m and from 1281.5 m to 1758 m (total: 980 m) was processed. By the end of the season, the CFA lab. had measured all the way from the surface to the beginning of the brittle zone, at 601.7 m.

Several associated projects were carried out: On-line water vapour isotope analysis, shallow ice coring, firn air pumping, British Antarctic Survey radar measurements and pit studies.

The brittle ice (601 m – 1281 m) continued to be an issue. It was difficult to keep temperatures in the drill trench and science trench low enough. To remedy this problem, two cooling tunnels were excavated with blowers to provide a cold firn air flow into the trenches. This helped, but as summer temperatures continued to climb, and the amount of dissipated heat from drilling and the CFA laboratory was high, cooling was not adequate. Therefore, several new cooling ideas will be implemented in the 2010 field season.



Scientific plan for NEEM 2010

The primary objective is continue the good quality drilling of 2009. Both in terms of drilling itself, with long, good quality cores in a routine stable mode while maintaining a low hole inclination, and in terms of continuing a productive ice core processing line. Based on experiences from 2009, we hope to be able to reach bedrock at approx. 2545 m depth this season.

However, calculations show that there most likely is basal melting at NEEM due to geothermal heat, similar to the situation at NGRIP. The basal melt rate is estimated to be low, so that the chances of getting ice from the entire Eemian and below are very good indeed.

Basal melting means that the ice in the deeper part of the ice sheet is “warm”, i.e. above -6 C, and this will influence ice core drilling. We don’t know to what extent the “warm” ice will cause problems. There are too many new factors compared to NGRIP, such as new drilling fluid and new drill configuration. Thus there are two scenarios in our planning: “warm” ice drilling and “cold” ice drilling. In the “warm” ice drilling scenario, drillers will switch to the short HT drill around 2400 m depth, and this will reduce weekly production from 160 m/week to 25 m/week. In this scenario, the Eemian will be passed around June 25, and bedrock will be reached on July 20. In the “cold” ice scenario, the Eemian will be passed June 18 and bedrock reached on June 25. In reality, the outcome will most likely be in between, if we do not encounter serious problems.

We hope to accomplish the deep coring objective with a team of 6 driller/loggers, a drill mechanic and an electronic engineer in shifts of two teams 16 hours a day. Please note, that ice core loggers have become part of the drilling crew.

For the processing line, both scenarios will lead to the same work load and duration of processing. In the “warm” ice situation, the processors will switch to processing of the brittle zone ice as soon as the drillers switch to the short HT drill. After brittle zone processing is complete, the processors will switch to deep ice processing. In the “cold” ice situation, the processors will switch to brittle ice processing after bedrock is reached. In both cases, processing should be complete by July 25. The processing line worked well in 2009, and no new procedures are planned, except for an improved storage of samples by added cooling.

The NEEM SC has decided, that the CFA team will work independently of the processing line. The goal of the CFA team is to measure 1000 m in 2010, with priority on the deep ice. This means, that the CFA team will return to NEEM in 2011 for measurement of the brittle ice. In 2010 the CFA analyses have expanded yet again. This has called for another warm lab. which will be installed in the beginning of the season. This year, CFA will include chemical analysis by flow chemistry and fast I.C., microparticle analysis by laser counter and flow cytometer, discrete sampling for cryptotephra, discrete sampling for microparticles, on-line laser measurements of stable water isotopes, on-line measurements of methane and methane isotopes and on-line measurements of black carbon.

The secondary objective is to support associated programs. Late April a Twin Otter will arrive with a PARCA shallow ice coring team. From NEEM the team will fly to PARCA site Humbolt and drill a shallow core. This shallow core will be flown back to NEEM for processing. Then the team will fly to PARCA site Tunu to drill another core, and then they will fly to SUMMIT.

Based on a successful pilot test last year, an on-line water vapour isotope sampling site will be set up again at NEEM.

Late July a New Zealand drilling team will arrive to conduct tests of a NZ version of the HT drill. The core has been assigned to U.S. CFA studies (Desert Research Institute) and Swedish 10Be studies. The hole will be left open for continued drilling in 2011.

The Danish shallow drill will drill a shallow core for trace metal studies for the Canadian Group, before the drill and two persons will be picked up by a Twin Otter on August 11 to fly to Camp Century and subsequently to Dye-3 for shallow coring at these old sites to bring the ice cores records there up to date.

Several groups have planned for pit studies if time permits.

In August, it is also planned to revisit some of the strain net sites on the surface in the vicinity of NEEM.

Logistic plan for NEEM 2010

The NEEM drilling project is a multi-year operation. In 2008 most main structures for the semi-permanent camp were constructed and in 2009 all construction tasks were completed. In 2010 the main logistic tasks are to facilitate transport of science equipment, ice core samples and 110 field participants to and from NEEM camp and to provide infrastructure, housing and food for up to 36 people in camp at one time. At the same time we have to keep the camp supplied with fuel and drilling fluid. In our planning, we have tried to maximize the efficiency of LC-130 flights. This means, that during the beginning of the season most cargo space is reserved for food, science and

drilling equipment. Towards the end of the season, when flights are needed to bring people, equipment and samples out, we fly in fuel and drilling fluid for staging over winter.

The NEEM ski-way will need attention immediately after camp opening. As the PARCA Twin Otter is planned to arrive in the first few days, we have to check markings. Furthermore, we need to obtain a good skiway before the 109th land again on May 11.

A team of 7 people, incl. the Field Leader, will handle camp logistics. In Kangerlussuaq one or two Field Operation Managers (FOMs) will maintain contact with camp, coordinate transportation of cargo and spareparts and organize housing and transportation of people.

Timeline.

The project is planned to take place from 27th April to 20th August 2009. Thus we plan for 16 weeks of work on the ice. Most of the main ice core will be shipped to Copenhagen during the season, and the cut isotope and gas samples and shallow cores will be sent to Copenhagen for distribution and to the U.S.

Publications and out-reach.

To enhance public interest in our work, we plan to have a web diary where the public may follow the progress on a day-to-day basis. Within the limits of logistical constraints some members of the press will also be invited to NEEM camp. Dorte Dahl-Jensen will organize a DV/press trip in conjunction with the planned flight on July 20th. A two person TV-team will be imbedded in camp in June. It is the Niels Bohr Institute's own outreach team, and their production will be versioned in English for general outreach through web TV.

Details on drilling.

The top part of the NEEM deep drill hole was drilled in 2008 from the surface to 106 m depth. The hole was subsequently reamed to large diameter and casing pipes were inserted. In 2009, drilling occurred mostly with the new NEEM drill, which produced 3.2 m cores on a regular basis.

Drilling in 2010 is expected to run in five phases:

1. Installation of the drill and readying infrastructure such as logging tables, drill fluid supply and tools (2 weeks).
2. Adjusting the drill. Establishing drilling routines (2 weeks).
3. Routine drilling (4-6 weeks).
4. "Warm" ice drilling (2-5 weeks).
5. Shallow coring (2-3 weeks).

The NEEM deep drill is a modified version of the NGRIP drill. The modifications have been necessary because of the introduction of a new drilling fluid with higher viscosity than the old fluid. New routines in handling the drill, in handling the ice cores and in handling drill fluid were developed in 2009 and they appear to work well. Still it is not realistic to predict exactly when a

certain depth is reached and when a productive drilling routine is re-established. In the planning, we have looked at the progress of previous drilling programs, GRIP and NGRIP, combined with NEEM experiences in 2009, so the odds for reaching bedrock this summer are good. However, we should never forget that ice core drilling is a high risk operation, and that a small technical break down may have severe consequences for progress.

The Danish shallow drill will be used to drill a 80 m+ core for trace metal studies.

The new New Zealand version of the HT drill will be tested late July and the core will be cut and split in camp for distribution to U.S. CFA studies and Swedish cosmogenic isotopes.

Details on science and processing plan.

The processing plan for 2010 is very ambitious. The following studies and analyses are planned:

Logging and documentation, All freshly drilled ice cores will be fitted to previous runs and core quality and integrity documented. Core depth and bag numbers will be assigned.

Di-electric properties measurements (DEP). This integrated AWI system records di-electric properties on the full and uncut core.

Cutting of sample sections (Horizontal band saw, or Swiss saw). Two cuts along the core axis will split the core in three for later processing.

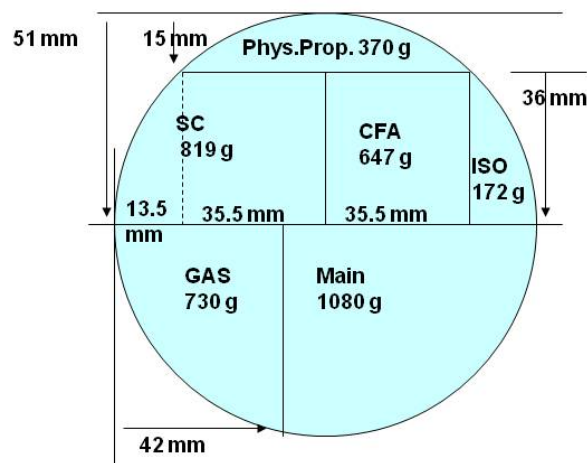

Electrical Conductivity Measurements (ECM). After the first cut in the horizontal saw, the core will be mounted in the Danish ECM setup for DC conductivity measurements. Afterwards, the core will be returned to the horizontal saw for cutting the central slab.

Line Scanning. The 36 mm thick central slab will be polished on both sides with a microtome knife and the scanned in the AWI line scanner.

Cutting of isotope samples. Samples for stable isotopes will be cut at band saws and packed individually.

Measurements of physical properties. Samples for measurements of physical properties will be packed; but for those analyses that require fresh ice, systems be set up in the science trench and in one of the warm labs.

Continuous Flow Analysis. A 34 mm x 34 mm section will be melted on a hot plate, two bags at a time and measured by the CFA team in one of the warm labs. A suite of chemical compounds, as well as dust and liquid conductivity will be measured. CFA activities also include a sampling program for screening for volcanic tephra, for microparticles and newly developed systems for online laser based water isotope measurements and measurements of methane and methane isotopes. This year a U.S. on-line system for measurement of black carbon as part of the CFA.

Cutting of gas samples. The gas science consortium has made an ambitious plan for sharing gas samples between several labs. Individual gas samples will be cut and packed in separate boxes for each lab.

Ice core packing. The main core (1/3 of the core cross section) will be packed in crates and sent to Copenhagen.

As with drilling, the first few weeks will be spent revising the core logging facility, re-adjusting tables in the science trench, mounting science equipment in the science trench and outfitting the three warm labs (physical properties, CFA and isotopes). Then the science team will work on establishing an ice core processing routine that minimizes the risk for errors and maximizes the processing rate.

Processors will follow a detailed ice core cutting, processing and sampling plan that has been made to comply with NEEM Steering Committee decisions.

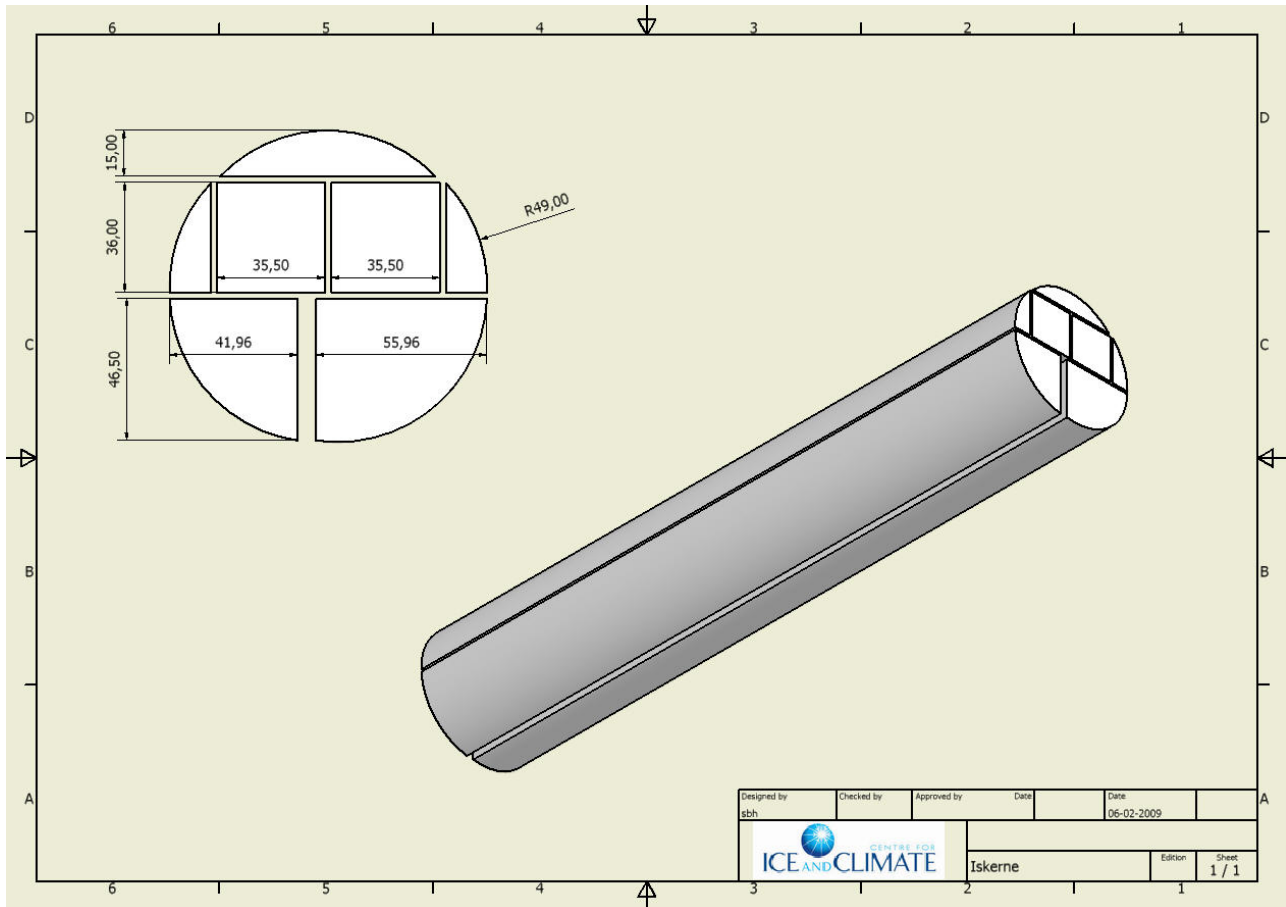

Important: Sudden changes in manning plan due unforeseen issues.

Please keep in mind, that being on the manning plan for 2010 is not a guarantee that you will go to NEEM and stay there for the scheduled time. In this line of work, even small incidents may have large consequences. Even though we are scientists, we also share a treat with sea-men – we are superstitious. Therefore we hesitate to mention specific incidents as it could become self-fulfilling. So, at this time let us just say, that a broken vital part with a long delivery time may cause severe delays.

THEREFORE: PEOPLE WHO ARE SCHEDULED FOR DEEP DRILLING, ICE CORE PROCESSING AND CFA IN JULY AND AUGUST SHOULD PREPARE THEMSELVES OF THE POSSIBILITY OF EITHER HAVING TO LEAVE CAMP EARLIER THAN PLANNED OR TO HAVE THEIR STAY CANCELLED. PLEASE FOLLOW THE DEVELOPMENTS ON THE NEEM HOME PAGE BEFORE YOU LEAVE FOR GREENLAND.

We are sorry for this inconvenience, but in our planning we have been forced to assume the most optimistic outcome of drilling, i.e. the situation where the most people are needed in processing and CFA. If we had planned for less, a smaller number of people would have been planned for, and we could end up in a situation where drilling had to be stopped due to lack of man-power in the processing line.

Shallow ice coring

One team, a DK/Australian led team will conduct shallow coring in the vicinity of NEEM. Their equipment will be setup in dome tents on the surface. The core will be used for Trace metal analysis.

Another team, a NZ team will conduct tests with the new NZ drill. The core will be used for US and Swedish analyses.

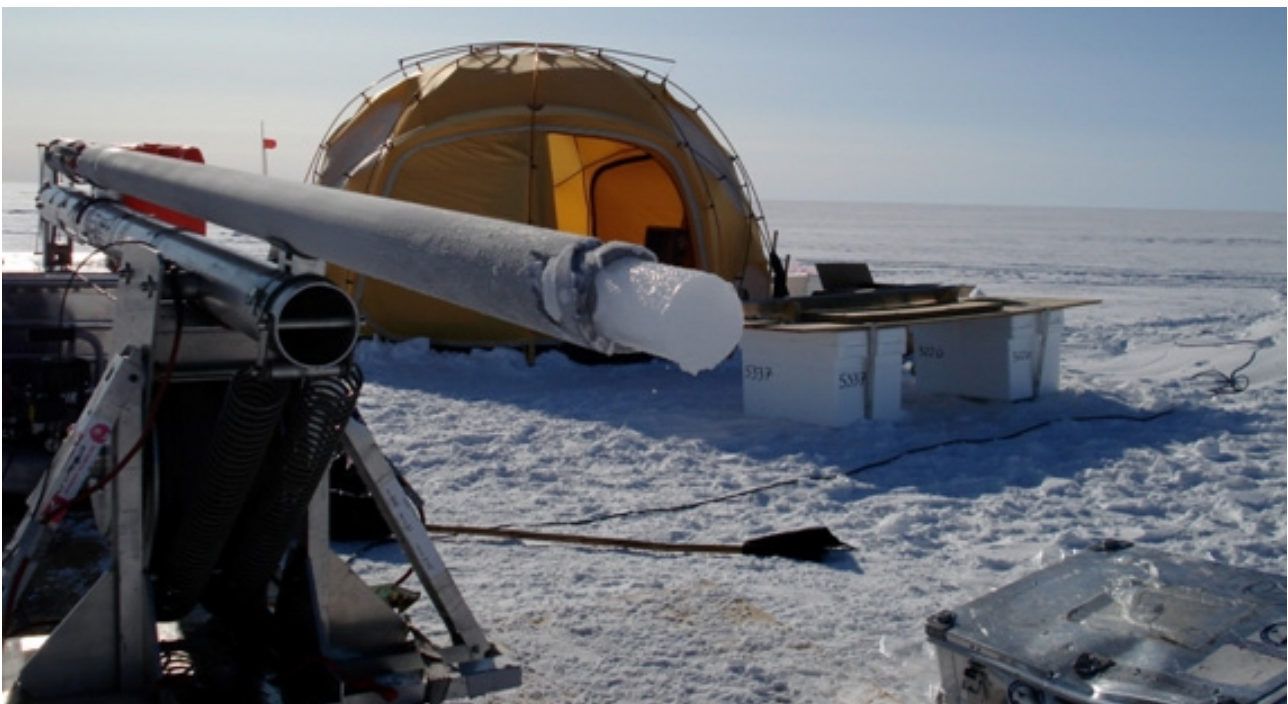

The Danish shallow drill at the Firn air sampling site in 2009.

Details on strain net.

The strain net along the traverse route to NGRIP was setup in 2007 and re-measured in 2008. This year no measurements are planned.

The strain net around NEEM was laid out in 2007 and re-measured in 2008 and consists of an inner and outer strainnet each consisting of four stakes in a square. The inner strainnet at a distance of one ice thickness, (2,5) km, to the NEEM reference pole. The outer strainnet at a distance of ten ice thicknesses away. If time permits, some re-measurements will be performed.

A NEEM reference point was established in 2008. In 2010 some of the strain net positions will be re-measured.

Positions of NEEM camp, NGRIP and 2007-2008 traverse route.

The final position markers have been measured by Lars Berg Larsen.

NGRIP position: 75.10N, 42.32W (decimal degrees), 2918 m a.s.l (9600 feet).

NEEM position: 77.45N, 51.06W (decimal degrees), 2484 m a.s.l. (8140 feet)

Start of route is approx. 2 km N of NGRIP camp.

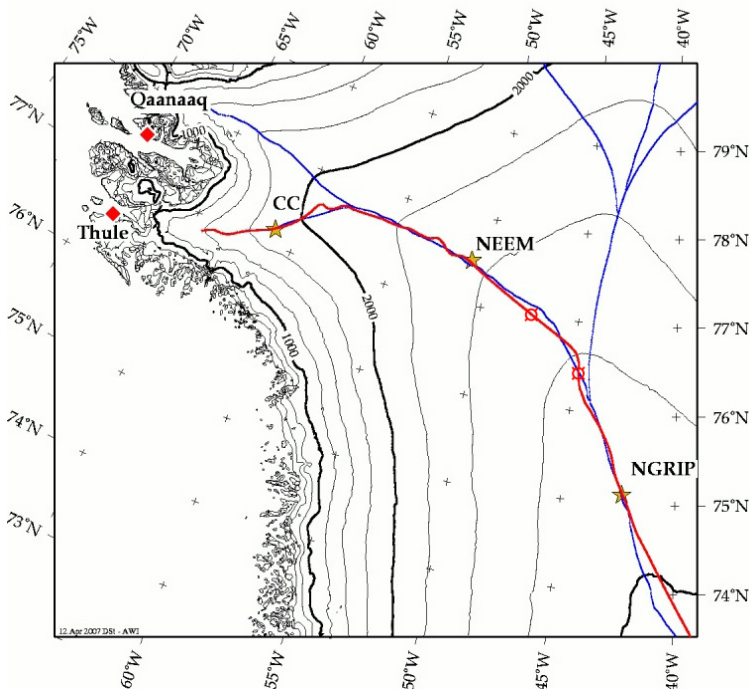

Fig. 5 1 The red line shows the 2007 and 2008 route from NGRIP to NEEM. The two circles indicate the two shallow ice coring sites in 2007.

Positions of NEEM skiway (official):

North end: N 77 degrees 27.969 min, W 51 degrees 2.793 min, alt. 2484 m

South end: N 77 degrees 25.941 min, W 51 degrees 2.471 min, alt. 2484 m

Skiways runs 358 and 178 degrees true.

Official (109th) altitude: 8,158 ft

List of waypoints

Way point	route distance	long.	lat.	altitude	Way point	route distance	long.	lat.	altitude
	Km	dec. deg	dec.deg	m		Km	dec. deg	dec.deg	m
	NGRIP (0)	75.111	-42.309	2916.7	38	190	76.66	-45.004	2740.3
1	5	75.152	-42.387	2913.1	39	195	76.691	-45.147	2732.5
2	10	75.192	-42.462	2909.5	40	200	76.721	-45.291	2724.7
3	15	75.233	-42.537	2906	41	205	76.747	-45.452	2716.8
4	20	75.274	-42.607	2902.5	42	210	76.772	-45.616	2709
5	25	75.316	-42.67	2899	43	215	76.797	-45.779	2701.2
6	30	75.359	-42.725	2895.6	44	220	76.821	-45.944	2693.4
7	35	75.402	-42.77	2892.3	45	225	76.844	-46.114	2685.3
8	40	75.446	-42.812	2888.8	46	230	76.867	-46.284	2677.2
9	45	75.49	-42.854	2885.3	47	235	76.89	-46.454	2669.1
10	50	75.533	-42.904	2881.5	48	240	76.913	-46.624	2661.1
11	55	75.575	-42.964	2877.7	49	245	76.936	-46.794	2652.9
12	60	75.617	-43.036	2873.6	50	250	76.96	-46.965	2644.5
13	65	75.657	-43.115	2869.5	51	255	76.983	-47.137	2636.2
14	70	75.697	-43.198	2865.2	52	260	77.006	-47.308	2627.8
15	75	75.736	-43.286	2860.7	53	Drilling (265)	77.029	-47.479	2619.5
16	80	75.776	-43.374	2856.2	54	270	77.052	-47.651	2611.1
17	85	75.815	-43.46	2851.6	55	275	77.075	-47.824	2602.6
18	90	75.855	-43.547	2846.8	56	280	77.097	-47.999	2594.1
19	95	75.891	-43.655	2841.6	57	285	77.12	-48.174	2585.6
20	100	75.928	-43.763	2836.3	58	290	77.142	-48.349	2577.1
21	105	75.965	-43.868	2831	59	295	77.165	-48.524	2568.6
22	110	76.002	-43.971	2825.6	60	300	77.187	-48.699	2560.1
23	115	76.038	-44.085	2820.2	61	305	77.21	-48.874	2551.6
24	120	76.073	-44.203	2814.8	62	310	77.232	-49.051	2542.9
25	125	76.109	-44.313	2809.5	63	315	77.254	-49.228	2534.2
26	130	76.15	-44.391	2804.7	64	320	77.277	-49.405	2525.5
27	135	76.19	-44.472	2799.9	65	325	77.299	-49.582	2516.8
28	140	76.23	-44.559	2795	66	330	77.321	-49.759	2508.1
29	145	76.271	-44.631	2790.2	67	335	77.344	-49.936	2499.1
30	150	76.315	-44.676	2785.7	68	340	77.367	-50.114	2490.1
31	155	76.359	-44.706	2781.2	69	345	77.39	-50.291	2481.1
32	160	76.403	-44.75	2776.1	70	350	77.413	-50.468	2472.1
33	Drilling (165)	76.448	-44.771	2771	71	355	77.437	-50.643	2463
34	170	76.493	-44.765	2766.1	72	360	77.461	-50.817	2453.9
35	175	76.537	-44.782	2760.5	73	365(NEEM)	77.485	-50.992	2444.8
36	180	76.581	-44.834	2754.2	74	370	77.505	-51.178	2435.6
37	185	76.622	-44.905	2747.5					

Waypoint 73 is 3 km NE of NEEM

Traverse route NEEM > NGRIP with GPS strain net stages

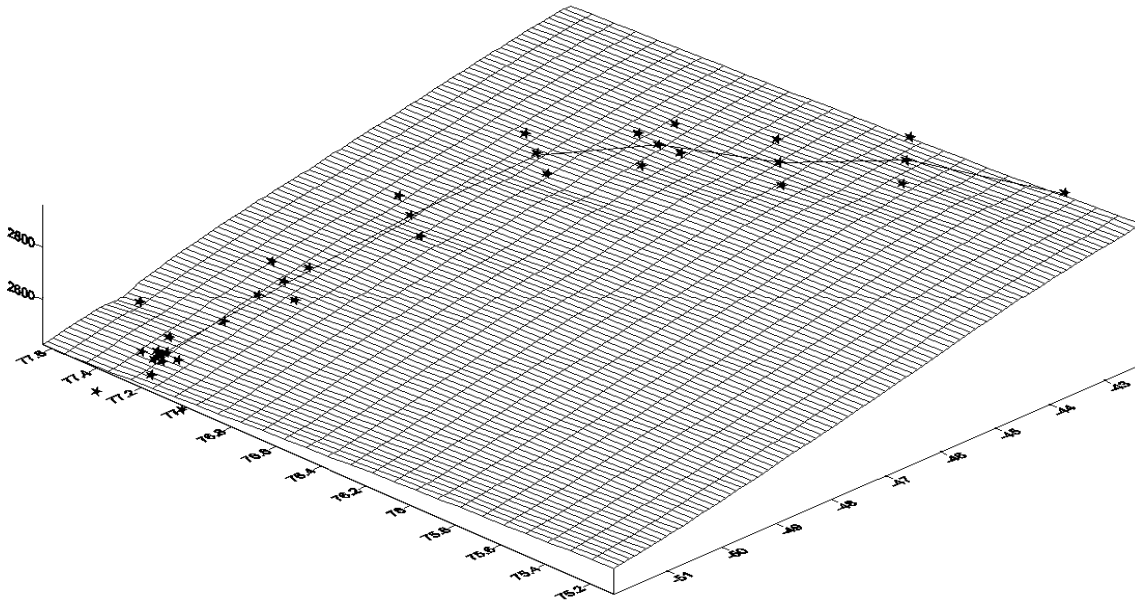

Name	Latitude	Longitude	Latitude	Longitude	Elev. Height	Lat-dms	Long-dms
CLA ITRF	77 27 58.0930	-51 01 53.1172	77,4661	-51,0314214	2481,31300000	2.481.313,0000	
MAR ITRF	77 26 03.5648	-50 58 47.0485	77,4343	-50,9797357	2485,24300000	2.485.243,0000	0.054 0.095
NEEM Reference ITRF	77 26 41.9520	-51 04 08.6526	77,445	-51,0690702	2480,58200000	2.480.582,0000	0.002 0.003
NGRIP Reference	75 05 47.3954	-42 19 42.4079	75,0965	-42,3284466	2957,10600000	2.957.106,0000	0.005 0.006
NGRIP Reference WCS84 (SOPAC)	75,09649867	317,6715543900			2955,49500000	2.955.495,0000	0.0161 0.0212
PET ITRF	77 25 30.3409	-51 07 12.3672	77,4251	-51,120102	2479,34900000	2.479.349,0000	0.012 0.032
SUS ITRF	77 27 21.1545	-51 09 30.2845	77,4559	-51,1584124	2475,80400000	2.475.804,0000	0.047 0.046
WP-13 ITRF	75 39 25.2634	-43 06 54.1247	75,657	-43,1150346	2906,46800000	2.906.468,0000	0.023 0.049
WP-13-A ITRF	75 36 41.3337	-43 25 33.2703	75,6115	-43,4259084	2905,27300000	2.905.273,0000	0.038 0.046
WP-13-A NAD-83	75 36 41.2850	-43 25 33.3007	75,6115	-43,4259169	2905,26000000	2.905.260,0000	0.038 0.046
WP-13-B ITRF-83	75 42 06.4916	-42 47 58.1033	75,7018	-42,7994731	2903,03200000	2.903.032,0000	0.042 0.066
WP-13-B NAD-83	75 42 06.4429	-42 47 58.1359	75,7018	-42,7994822	2903,01400000	2.903.014,0000	0.042 0.066
WP-23 ITRF	76 02 16.9748	-44 05 05.7534	76,038	-44,0849315	2858,09000000	2.858.090,0000	0.024 0.041
WP-23-A ITRF	75 58 26.1533	-44 20 44.7912	75,9739	-44,3457753	2855,56000000	2.855.560,0000	0.026 0.033
WP-23-B ITRF	76 06 05.3187	-43 49 11.7223	76,1015	-43,8199229	2853,85900000	2.853.859,0000	0.049 0.043
WP-31 ITRF	76 21 32.3098	-44 42 21.7799	76,359	-44,70605	2815,13300000	2.815.133,0000	0.031 0.062
WP-33 ITRF	76 26 52.7992	-44 46 16.6464	76,448	-44,7712907	2807,25700000	2.807.257,0000	0.005 0.007
WP-33-A ITRF	76 26 50.5697	-45 09 09.1353	76,4474	-45,1525376	2798,98600000	2.798.986,0000	0.018 0.043
WP-33-B ITRF	76 26 48.7695	-44 23 14.6405	76,4469	-44,3874001	2812,00700000	2.812.007,0000	0.042 0.039
WP-35 ITRF	76 32 13.3585	-44 46 54.9945	76,537	-44,7819429	2798,20800000	2.798.208,0000	0.018 0.020
WP-43 ITRF	76 47 49.6543	-45 46 46.4402	76,7971	-45,7795667	2740,03700000	2.740.037,0000	0.053 0.102
WP-43-A ITRF	76 43 00.7018	-45 57 22.1422	76,7169	-45,9561506	2747,90800000	2.747.908,0000	0.048 0.041
WP-43-B ITRF	76 52 47.5722	-45 37 28.5509	76,8799	-45,6245975	2735,16200000	2.735.162,0000	0.020 0.033
WP-53 ITRF	77 01 44.3634	-47 28 45.8452	77,029	-47,4794014	2661,04900000	2.661.049,0000	0.014 0.030
WP-53-A ITRF	76 56 56.1690	-47 39 38.9273	76,9489	-47,6608131	2664,44800000	2.664.448,0000	0.041 0.057
WP-53-B ITRF	77 06 43.3435	-47 19 27.8550	77,112	-47,3244042	2658,21700000	2.658.217,0000	0.011 0.018
WP-61 ITRF	77 12 36.3099	-48 52 27.0389	77,2101	-48,8741775	2596,13900000	2.596.139,0000	0.040 0.033
WP-63 ITRF	77 15 14.0872	-49 13 40.9971	77,2539	-49,2280548	2580,74800000	2.580.748,0000	0.030 0.032
WP-63-A ITRF	77 10 12.8721	-49 22 52.2526	77,1702	-49,3811813	2577,50800000	2.577.508,0000	0.034 0.042
WP-63-B	77 20 14.8850	-49 04 34.1969	77,3375	-49,0761658	2581,93700000	2.581.937,0000	0.102 0.068
WP-65 ITRF	77 17 56.5816	-49 34 55.8100	77,2991	-49,5821694	2559,41000000	2.559.410,0000	0.049 0.093
WPN-001 ITRF	77 25 36.0321	-51 22 11.7835	77,4267	-51,3699399	2467,12200000	2.467.122,0000	0.078 0.060
WPN-002 ITRF	77 30 34.9697	-51 09 16.2549	77,5097	-51,1545152	2471,07200000	2.471.072,0000	0.041 0.043

Strain net around NEEM site

Name	Latitude	Longitude	Antenna height
WPN-299	77,5509236	-51,9796059	2430,33 2.45
WPN-209	77,2490623	-51,5625473	2456,75 2.54
WPN-001	77,4266756	-51,3699399	2467,12 2.61
WPN-002	77,5097138	-51,1545152	2471,07 2.60
SUS	77,4558763	-51,1584124	2475,80 2.55
WPN-029	77,63987	-50,5627345	2475,87 2.51
PET	77,4250947	-51,120102	2479,35 2.45
NEEM Reference	77,4449867	-51,0690702	2480,58 2.00
CLA	77,4661369	-51,0314214	2481,31
MAR	77,4343236	-50,9797357	2485,24 2.08
WPN-021	77,3801657	-50,9850457	2487,24 2.56
WPN-022	77,4634856	-50,7702814	2491,47 2.51
WPN-119	77,3350287	-50,1733762	2531,77 2.40

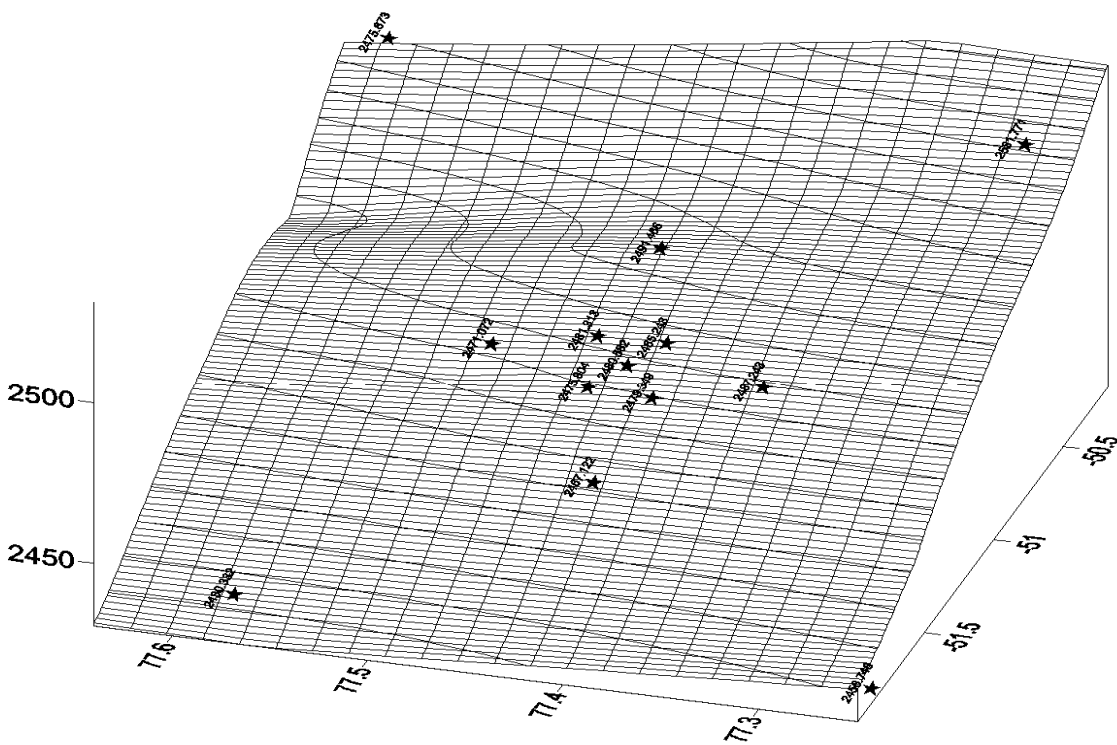

Associated project: Earthquake station at NEEM

Trine Dahl-Jensen and Tine B. Larsen, GEUS.

Starting in 2000, the seismological groups at KMS and GEUS – now all at GEUS – have placed earthquake seismic stations at over 20 sites in Greenland, both on the coast and on the ice sheet. We record globally occurring earthquakes, and use the data to investigate the local structure beneath and between the stations. A station placed at NEEM will fit into the network very well; we always seek to place more stations on the ice sheet.

The station will consist of a Broad-Band (up to 120 sec period) STS-2 seismometer, a data logger with data storage on flashcards, GPS (for time) and batteries charged by a solar panel. The seismometer will initially be dug down approx. 2m under the surface, but when NEEM camp is established we will move the seismometer to a small side cave off one of the camps labs or the food freezer. Thus re-levelling the instrument will not require digging a several meters deep pit.

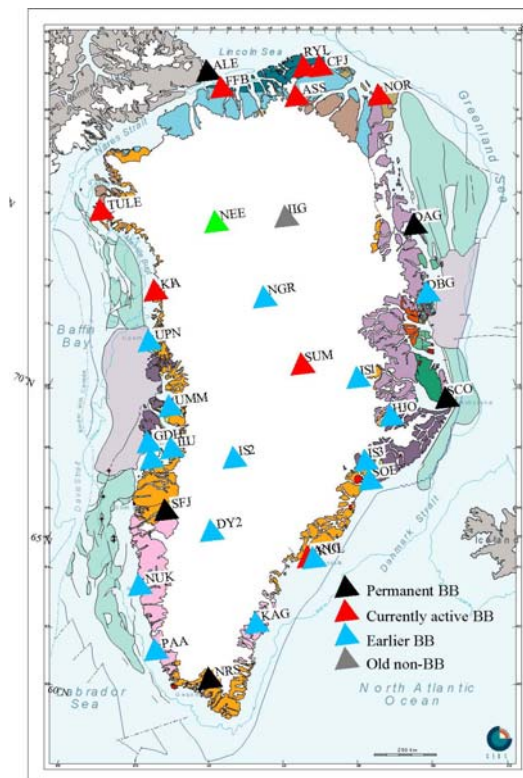

Data quality from stations on the ice sheet is very good; the station at NGRIP (NGR) provided sufficient data for an analysis of crustal thickness in just one summer season. The crust at NGR is 42 km thick.

The seismic station is installed in a niche in the wall of the science trench. In 2009, data will be downloaded and the station maintained by NEEM personnel.

Contact: Trine Dahl-Jensen tdj@geus.dk, work phone +45 3814 2519, mobile phone +45 2047 5962.

NEEM 2010 schedule

Monday, 19 April:	NEEM FOM office opens in Kangerlussuaq.
Tuesday, 27 April:	Put-in at NEEM, 14 PAX, CFA basic equipment. Camp is opened. Main generator is mounted. Erection of weatherports and tents. Open access to drill and science trenches. Construction work in science trench, new warm lab. Working on wall in drill trench and cooling tunnels in science trench. Skiway grooming. Outfitting science trench and drill trench. Mounting of drill.
Thursday, 29 April:	Twin Otter arrives with PARCA and shallow coring crews. Humbolt core is left at NEEM.
Friday, 30 April:	Twin Otter goes to Tunu and onwards to Summit.
Tuesday, 11 May:	27 PAX up. 3 PAX down. Drilling and processing crews arrive. Skiway evaluation and upgrade.
Thursday, 13 May:	No PAX to camp, 1 PAX from camp. Fluid, food and science cargo. Processing line in science trench made ready. Begin drilling and logging. First cores. Begin processing. Work on setup of CFA system. Maintenance of NEEM computer network.
Thursday, 3 June:	Crew exchange. Food and cargo. 18 PAX to NEEM. 23 PAX from NEEM. Drilling and processing at 2080 m.
Tuesday, 22 June:	Crew exchange. 17 PAX to camp. 13 PAX from camp. Ice to SFJ. Trash to SFJ. Drilling and processing. Outreach filming. Drilling and processing at 2420 m. Possibly switch to HT warm ice drilling mode.
Tuesday, 29 June:	Crew exchange. 18 PAX to NEEM. 22 PAX from NEEM. Likelihood of warm ice drilling. Either processing deep ice (large drill in operation) or processing of brittle zone ice (HT drill in operation).
Tuesday, 20 July:	Press and DV visit. Crew exchange. 10 PAX to camp. 8 PAX from camp. 20 DV PAX. Drilling and processing completed to 2545 m. Packing down of processing line. CFA continues. New Zealand drill arrives.
Wednesday, 28 July:	5 PAX to NEEM. 22 PAX from NEEM. Core troughs out. Equipment out. Pull out of part of processing line. Pull out of CFA line. Shallow drilling and surface work begins.
Thursday, 12 August:	Twin Otter arrives to NEEM with 7 DV's. Pick-up DK shallow drill and 2 PAX for Camp Century drilling.
Friday, 13 August:	Twin Otter departs with DV's
Sunday, 15 August:	Twin Otter with drill at Dye-3.
Tuesday, 17 August:	8 PAX down. 1 st pull-out.
Wednesday, 18 August:	8 PAX down. NEEM camp closes.
Monday 23 August:	NEEM FOM office closes.

NEEM Manning 2010

Sorted by arrival dates	Name	Country	To SFJ	To NEEM	From NEEM	From SFJ	Number of days in camp.	Number of days in KISS
FOM	Berg Larsen, Lars	DK	19-Apr			23-Apr	0	4
FOM	Holm Hansen, Lone	DK	19-Apr			13-May	0	24
FIELD LEADER	Steffensen, Jørgen Peder	DK	26-Apr	27-Apr	22-Jun	24-Jun	56	3
MECHANIC	Hilmarsson, Sverrir Æ.	IS	26-Apr	27-Apr	29-Jun	01-Jul	63	3
CARPENTER	Svavarsson, Adalsteinn	IS	26-Apr	27-Apr	03-Jun	05-Jun	37	3
COOK	Harvey, Sarah	US	26-Apr	27-Apr	29-Jun	01-Jul	63	3
DOCTOR	Florian, Hans Chr.	GRL	26-Apr	27-Apr	11-May	13-May	14	3
DRILL MECHANIC	Hansen, Steffen Bo	DK	26-Apr	27-Apr	03-Jun	05-Jun	37	3
ELECTRONICS	Sheldon, Simon	DK	26-Apr	27-Apr	11-May	13-May	14	3
ELECTRONICS	Schwander, Jakob	CH	26-Apr	27-Apr	03-Jun	05-Jun	37	3
FIELD ASSISTANT	Albershart, Louise	US	26-Apr	27-Apr	29-Jun	01-Jul	63	3
DRILLER	Popp, Trevor	DK	26-Apr	27-Apr	29-Jun	01-Jul	63	3
PACKING	Severinghaus, Jeff	US	26-Apr	27-Apr	11-May	13-May	14	3
PHYSICAL PROP.	Kipfstuhl, Sepp	D	26-Apr	27-Apr	29-Jun	01-Jul	63	3
CFA	Bigler, Matthias	CH	26-Apr	27-Apr	03-Jun	05-Jun	37	3
CFA (gases)	Jenk, Theo	DK	26-Apr	27-Apr	11-May		14	1
FOM	Berg Larsen, Lars	DK	27-Apr			30-Jun	0	64
Ass COOK	Sørensen, Maibritt W.	DK	10-May	11-May	03-Jun	05-Jun	23	3
DOCTOR	Kjærgaard, Marie	DK	10-May	11-May	03-Jun	05-Jun	23	3
ELECTRONICS	Leonhardt, Martin	D	10-May	11-May	22-Jun	24-Jun	42	3
FIELD ASSISTANT	Panton, Christian	DK	10-May	11-May	03-Jun	05-Jun	23	3
DRILLER	Duphil, Romain	F	10-May	11-May	03-Jun		23	1
DRILLER	Schildt, Adrian	CH	10-May	11-May	22-Jun	24-Jun	42	3
DRILLER	Triest, Jack	UK	10-May	11-May	03-Jun	05-Jun	23	3
LOGGER/DRILLER	Gkinis, Vasileios	DK	10-May	11-May	03-Jun		23	1
O18 CUTTING	Petersen, Anne Wang	DK	10-May	11-May	03-Jun	05-Jun	23	3
ECM	Vinther, Bo	DK	10-May	11-May	03-Jun		23	1
LINE SCANNER	Stowasser, Christoffer	DK	10-May	11-May	03-Jun	05-Jun	23	3
SWISS SAW	Azuma, Kumiko	J	10-May	11-May	03-Jun	05-Jun	23	3
DEP	Köhler, Peter	D	10-May	11-May	03-Jun	05-Jun	23	3
PACKING (CFA)	McConnell, Joe	US	10-May	11-May	03-Jun	05-Jun	23	3
PHYSICAL PROP.	Sato, Motoyuki	J	10-May	11-May	03-Jun	05-Jun	23	3
CFA	Schüpach, Simon	CH	10-May	11-May	22-Jun	24-Jun	42	3
CFA	Leuenberger, Daiana	CH	10-May	11-May	28-Jul	30-Jul	78	3
CFA (FIC)	Mulvaney, Robert	UK	10-May	11-May	03-Jun	05-Jun	23	3
CFA (cytometer)	Kettner, Ernesto	DK	10-May	11-May	03-Jun	05-Jun	23	3

CFA (helper)	Twarloh, Birthe	D	10-May	11-May	03-Jun	05-Jun	23	3
CFA (gases)	Blunier, Thomas	DK	10-May	11-May	03-Jun	05-Jun	23	3
CFA (gases)	Dallmayr, Remi	F	10-May	11-May	03-Jun	05-Jun	23	3
ISOTOPES Vapour	Steen-Larsen, H.C.	DK	10-May	11-May	03-Jun		23	1
POLLEN	Bourgeois, Jocelyne	CAN	10-May	11-May	29-Jun	01-Jul	49	3
O18 CUTTING	Jenk, Theo	DK		11-May	03-Jun	05-Jun	23	1
Ass COOK	Ravnebjerg, Louise Wolff	DK	02-Jun	03-Jun	29-Jun	01-Jul	26	3
DOCTOR	Uhl-Jensen, Simon	DK	02-Jun	03-Jun	29-Jun	01-Jul	26	3
DRILLER	Wang Shimeng	CHN	02-Jun	03-Jun	22-Jun	24-Jun	19	3
LOGGER/DRILLER	Teste, Gregory	F	02-Jun	03-Jun	20-Jul	22-Jul	47	3
O18 CUTTING	Zhang Tong	CHN	02-Jun	03-Jun	22-Jun	24-Jun	19	3
O18 CUTTING	v.d.Veen, Carina	NL	02-Jun	03-Jun	29-Jun	01-Jul	26	3
ECM	Sapart, Celia	NL	02-Jun	03-Jun	22-Jun	24-Jun	19	3
SWISS SAW	Uetake, Jun	J	02-Jun	03-Jun	29-Jun	01-Jul	26	3
DEP	Schmidt, Astrid	DK	02-Jun	03-Jun	22-Jun	24-Jun	19	3
PACKING	Hwang, Heejin	COR	02-Jun	03-Jun	29-Jun	01-Jul	26	3
PHYSICAL PROP.	Samyn, Denis	S	02-Jun	03-Jun	29-Jun	01-Jul	26	3
CFA	Gfeller, Gideon	CH	02-Jun	03-Jun	28-Jul	30-Jul	55	3
CFA (FIC)	Thomas, Liz	UK	02-Jun	03-Jun	29-Jun	01-Jul	26	3
CFA (cytometer)	Kjær, Helle Astrid	DK	02-Jun	03-Jun	22-Jun	24-Jun	19	3
CFA (helper)	Schmidt, Kerstin	D	02-Jun	03-Jun	22-Jun	24-Jun	19	3
CFA (Iso. and vap.)	Falourd, Sonia	F	02-Jun	03-Jun	29-Jun	01-Jul	26	3
BIOLOGY	Sowers, Todd	US	02-Jun	03-Jun	06-Jun		3	1
DRILL MECHANIC	Duphil, Romain	F		03-Jun	29-Jun	01-Jul	26	2
DRILLER	Steen-Larsen, H.C.	DK		03-Jun	29-Jun	01-Jul	26	2
LOGGER/DRILLER	Vinther, Bo	DK		03-Jun	22-Jun	24-Jun	19	2
CFA (Iso. and vap.)	Gkinis, Vasilios	DK		03-Jun	29-Jun	01-Jul	26	2
LINE SCANNER	Sowers, Todd	US		06-Jun	22-Jun	24-Jun	16	2
FIELD LEADER	Svensson, Anders	DK	21-Jun	22-Jun	29-Jun		7	1
MECHANIC	Arntorsson, Gunnar Magnus	IS	21-Jun	22-Jun	28-Jul	30-Jul	36	3
COOK	Hviid, Rene	DK	21-Jun	22-Jun	18-Aug	20-Aug	57	3
ELECTRONICS	Jønch Andersen, Jeppe	DK	21-Jun	22-Jun	20-Jul	22-Jul	28	3
DRILLER	Chung, JiWoong	COR	21-Jun	22-Jun	28-Jul	30-Jul	36	3
DRILLER	Johnsen, Sigfus	DK	21-Jun	22-Jun	20-Jul	22-Jul	28	3
LOGGER/DRILLER	Bjerregaard, Sebastian	DK	21-Jun	22-Jun	28-Jul	30-Jul	36	3
LOGGER/DRILLER	Karlin, Thorbjörn	S	21-Jun	22-Jun	20-Jul	22-Jul	28	3
O18 CUTTING	Hansson, Margareta	S	21-Jun	22-Jun	20-Jul	22-Jul	28	3
ECM	Rosen, Julia	US	21-Jun	22-Jun	28-Jul	30-Jul	36	3
LINE SCANNER	Tison, Jean Louis	B	21-Jun	22-Jun	20-Jul	22-Jul	28	3
DEP	Lâpple, Thomas	D	21-Jun	22-Jun	20-Jul	22-Jul	28	3
CFA	Wegner, Anna	D	21-Jun	22-Jun	28-Jul	30-Jul	36	3
CFA (FIC)	Abram, Nerilie	UK	21-Jun	22-Jun	28-Jul	30-Jul	36	3
CFA (cytometer)	Vallelonga, Paul	DK	21-Jun	22-Jun	28-Jul	30-Jul	36	3

Outreach	Andersen, Torben	DK	21-Jun	22-Jun	29-Jun	01-Jul	7	3
Outreach	Skaarup, Gertie	DK	21-Jun	22-Jun	29-Jun	01-Jul	7	3
FOM	Thing, Henning	DK	22-Jun			10-Jul	0	18
FIELD LEADER	Dahl-Jensen, Dorthe	DK	28-Jun	29-Jun	18-Aug	20-Aug	50	3
Ass COOK	Skrydstrup, Martin	DK	28-Jun	29-Jun	28-Jul	30-Jul	29	3
DOCTOR	Elliott, Elizabeth	AUS	28-Jun	29-Jun	18-Aug	20-Aug	50	3
DRILL MECHANIC	Hansen, Steffen Bo	DK	28-Jun	29-Jun	20-Jul	22-Jul	21	3
FIELD ASSISTANT	Burton, Timothy	UK	28-Jun	29-Jun	18-Aug	20-Aug	50	3
DRILLER	Delgado, Fernando Valero	D	28-Jun	29-Jun	28-Jul	30-Jul	29	3
DRILLER	Aleman, Olivier	F	28-Jun	29-Jun	20-Jul	22-Jul	21	3
O18 CUTTING	Reutenauer, Corentin	DK	28-Jun	29-Jun	28-Jul	30-Jul	29	3
SWISS SAW	van der Wel, Gerko	CH	28-Jun	29-Jun	28-Jul	30-Jul	29	3
PACKING	Kawamura, Kenji	J	28-Jun	29-Jun	28-Jul	30-Jul	29	3
PHYSICAL PROP.	Weikusat, Ilka	D	28-Jun	29-Jun	20-Jul	22-Jul	21	3
CFA (helper)	Abbott, Peter	UK	28-Jun	29-Jun	20-Jul	22-Jul	21	3
CFA (gases)	Balslev-Clausen, David	DK	28-Jun	29-Jun	28-Jul	30-Jul	29	3
CFA (gases)	Chappellaz, Jerome	F	28-Jun	29-Jun	28-Jul	30-Jul	29	3
PHYSICAL PROP.	Svensson, Anders	DK		29-Jun	28-Jul	30-Jul	29	2
FOM	Hvidberg, Christine	DK	07-Jul			27-Jul	0	20
FOM	Steffensen, Jørgen Peder	DK	18-Jul			23-Aug	0	36
MECHANIC	Hilmarsson, Sverrir Æ.	IS	19-Jul	20-Jul	18-Aug	20-Aug	29	3
DRILL MECHANIC	Rufli, Henry	CH	19-Jul	20-Jul	18-Aug	20-Aug	29	3
ELECTRONICS	Sheldon, Simon	DK	19-Jul	20-Jul	17-Aug	19-Aug	28	3
DRILLER	Curran, Mark	AUS	19-Jul	20-Jul	18-Aug	20-Aug	29	3
LOGGER/DRILLER	Grindstad, Aslak	DK	19-Jul	20-Jul	17-Aug	19-Aug	28	3
LOGGER/DRILLER	Brand, Tina	DK	19-Jul	20-Jul	17-Aug	19-Aug	28	3
O18 CUTTING	Zabori, Julia	S	19-Jul	20-Jul	17-Aug	19-Aug	28	3
LINE SCANNER	White, Jim	US	19-Jul	20-Jul	28-Jul	30-Jul	8	3
DEP	Dummermuth, Angelika	D	19-Jul	20-Jul	18-Aug	20-Aug	29	3
PHYSICAL PROP.	Kipfstuhl, Sepp	D	19-Jul	20-Jul	17-Aug	19-Aug	28	3
SHALLOW (NZ)	Pasteris, Dan	US	19-Jul	20-Jul	17-Aug	19-Aug	28	3
SHALLOW (NZ)	Pyne, Alex	NZ	19-Jul	20-Jul	17-Aug	19-Aug	28	3
SHALLOW (NZ)	Mandeno, Darcy Robert	NZ	19-Jul	20-Jul	17-Aug	19-Aug	28	3
FIELD ASSISTANT	Berg Larsen, Lars	DK	27-Jul	28-Jul	18-Aug	20-Aug	21	3
DRILL OBSERVER	Kuhl, Tanner	US	27-Jul	28-Jul	17-Aug	19-Aug	20	3
ECM	Jouzel, Jean	F	27-Jul	28-Jul	17-Aug	19-Aug	20	3
SHALLOW (DK)	Zheng, James	CAN	27-Jul	28-Jul	17-Aug	19-Aug	20	3
SHALLOW (DK)	Berggren, Anne Marie	S	27-Jul	28-Jul	17-Aug	19-Aug	20	3
SHALLOW (DK)	Andres, Heather	CAN	27-Jul	28-Jul	17-Aug	19-Aug	20	3
BOREHOLE	Hubbard, Bryn	UK	27-Jul	28-Jul	17-Aug	19-Aug	20	3
							0	0
	Totals						3281	483

GANNT sheets.

FOM's:

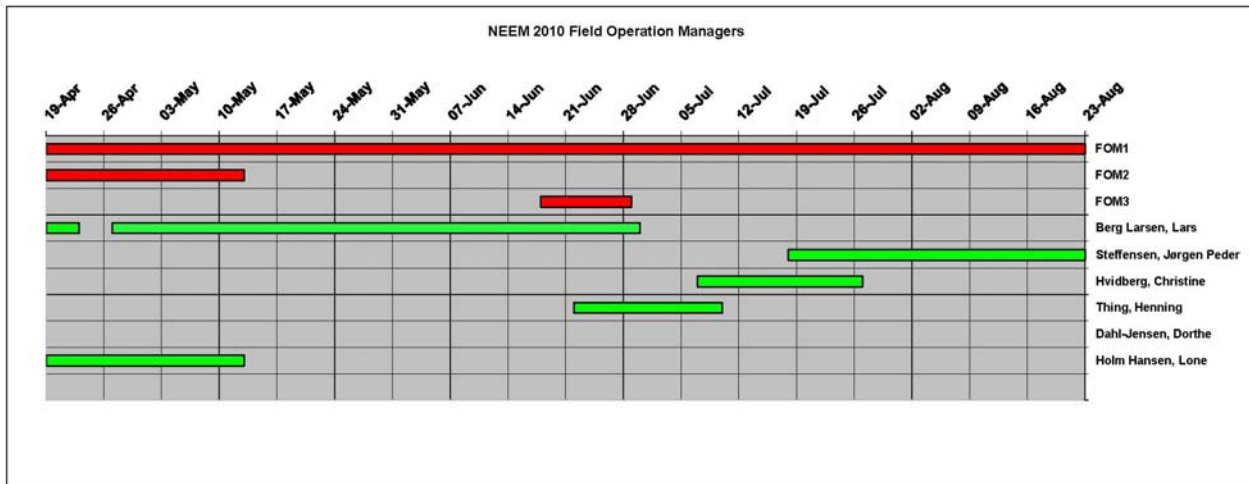

Logistics crew:

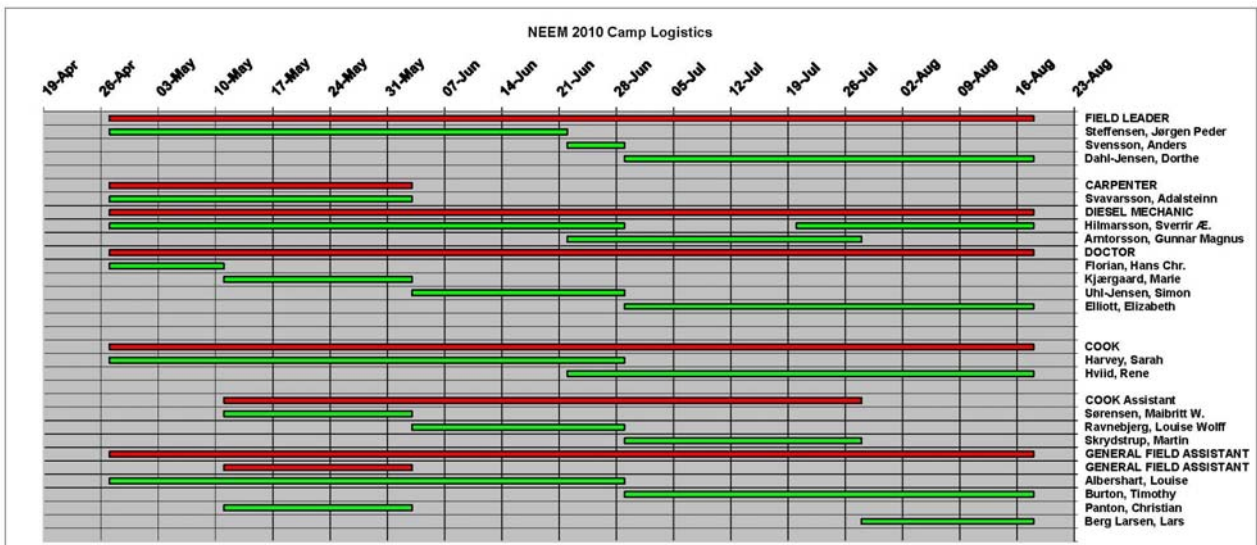

Drilling crew:



Processing crew:

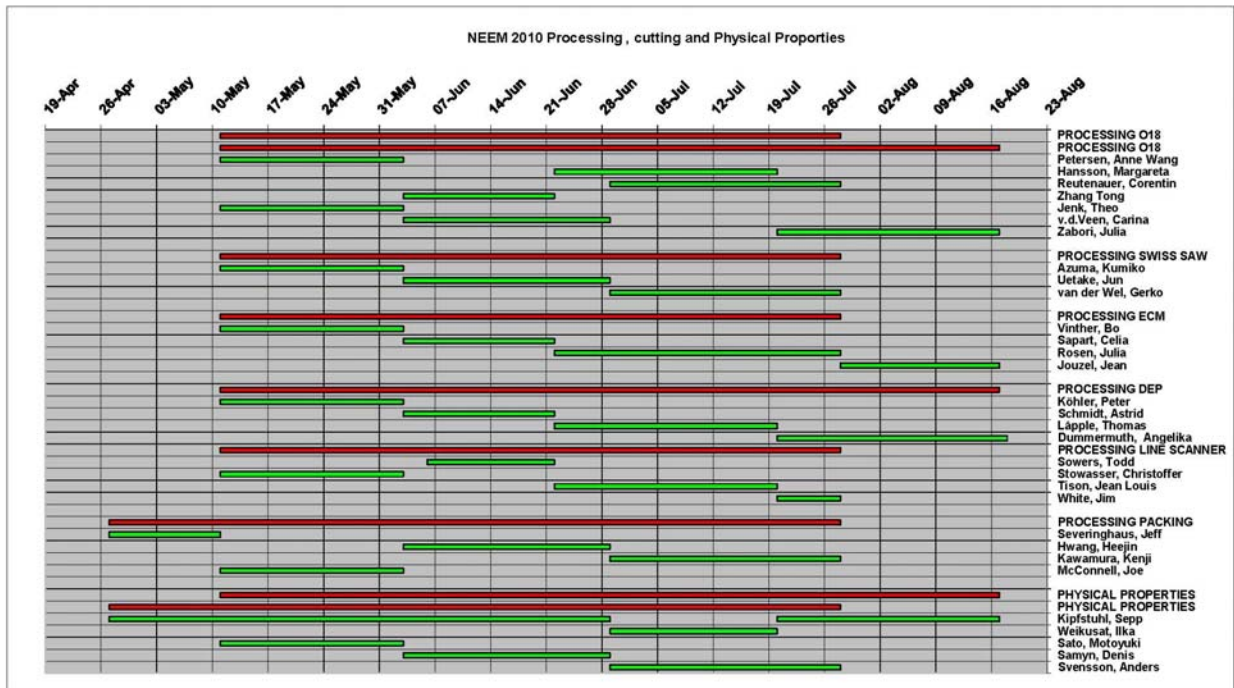

CFA crew:

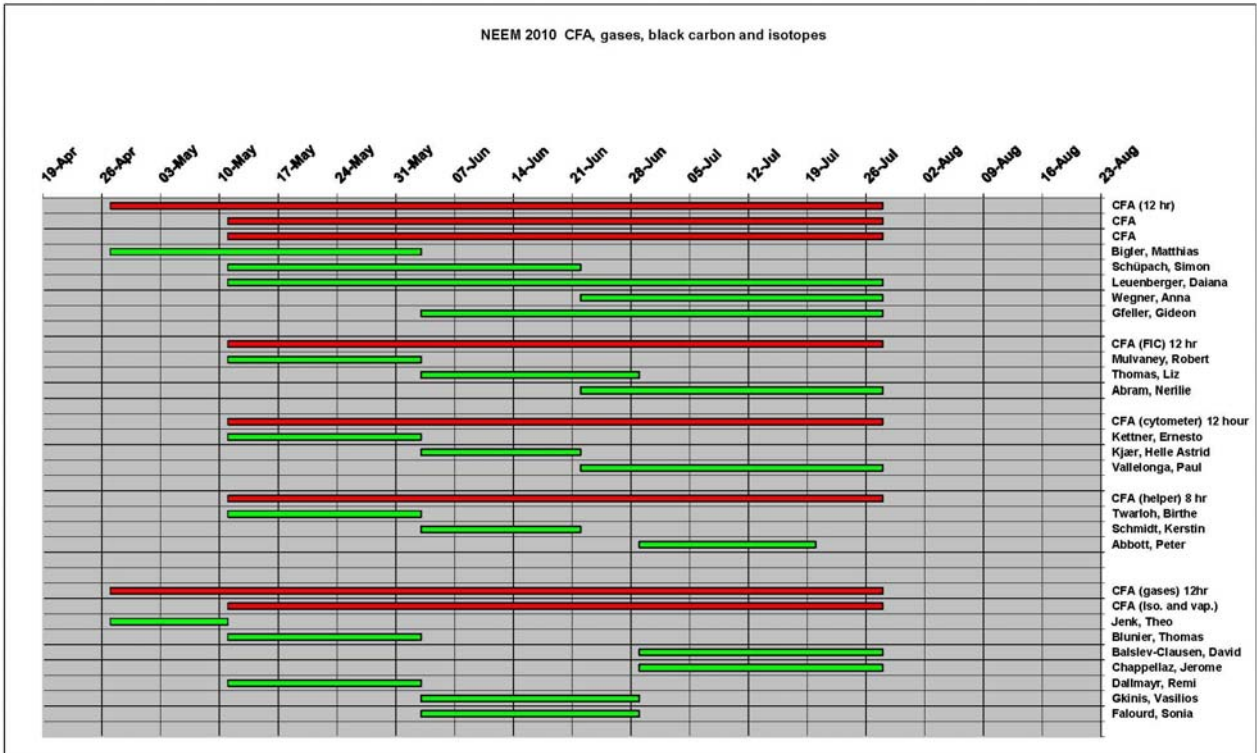

Associated programs crew:

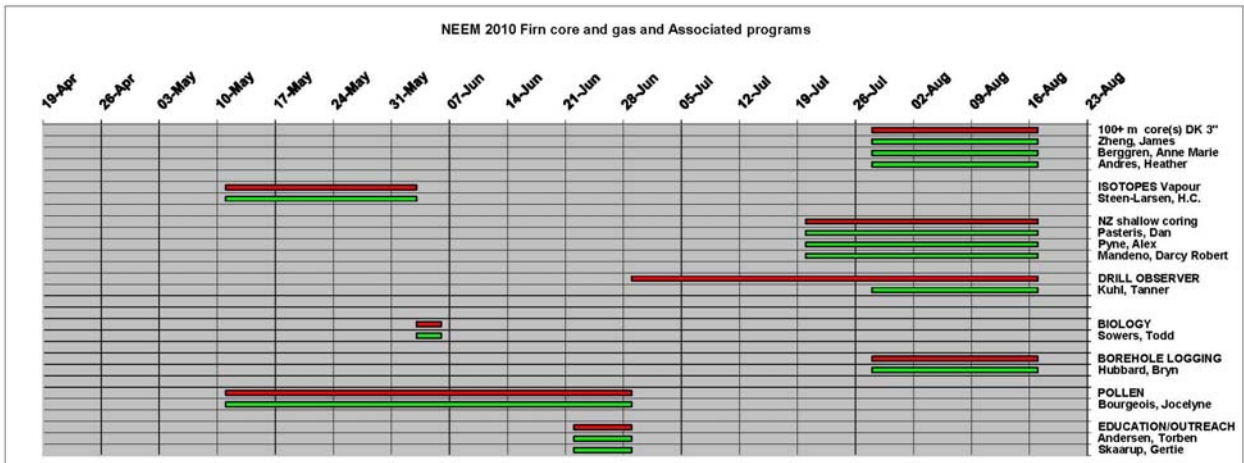

Camp population

The diagram below gives an overview on the population in camp.

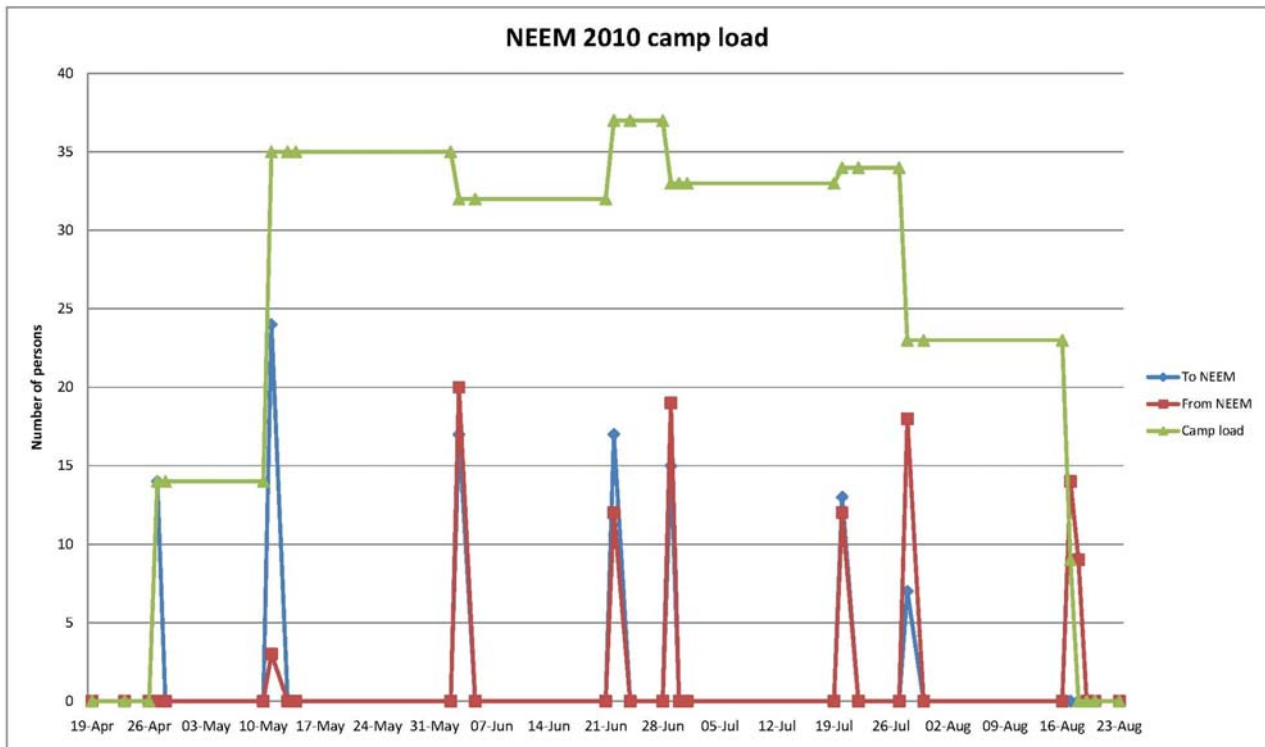

The DV and press visit July 20th

NEEM considers outreach to both the press and to political decision makers as an issue of great importance. Already at the writing stage (March) there is an overwhelming interest from the press to cover NEEM activities this year. In order to meet as many demands as possible and at the same time create as little disturbance as possible, we have arranged for a Distinguished Visitor (DV) and Press trip on July 20th . Absolute maximum attendance for the DV trip is 20. Dortehe Dahl-Jensen will be coordinating the trip.

Handling of Waste and environmentally hazardous chemicals

NEEM has been imposed with strict environmental conditions on NEEM camp operations by the Greenland government. As NEEM camp is located in a pristine area of the Greenland ice sheet, the camp is constructed to reduce the environmental impact as much as possible, e.g. by using wood and snow as primary construction materials and by using temporary tent structures to maximum extent.

In NEEM camp strict guidelines of waste management will be enforced.

LITTERING IS NOT ALLOWED. It is the duty of everybody to pick up any litter encountered.

Any traffic outside the general camp area has to be sanctioned by the Field Leader.

All waste will have to be sorted into the following categories:

- Natural combustible (e.g. wood, card board)

- Kitchen Waste

- Glasware

- Metal (e.g. cans, nails and screws).

- Hazardous solids (e.g. batteries, PVC)

- Hazardous fluids (e.g. fuel, hydraulic fluid, drill fluid).

All glassware, metal and hazardous material and kitchen waste will be retrograded to Kangerlussuaq for further processing.

To limit possible spills of fuel, only authorized personnel is allowed to operate pumps for fuel transfer.

All spills of hazardous fluids to the snow have to be excavated and the polluted snow has to be deposited in a salvage drums.

Use only designated toilets. Urination is only allowed at designated spots (pee-poles).

Special rules apply for fuel handlers, heavy vehicle operators and mechanics: A daily check on fuel tanks, pump system and hazardous chemical storage is necessary to insure no leakage to the environment.

Fire hazards

Camp structures are spaced so that an accidental fire will not spread to other structures.

Carbondioxide extinguishers and fire blankets will be placed at all locations where fuel is handled, in the kitchen and on the first floor of the main dome.

Only one of the three main fuel tanks will be in camp at any time. The other two will be at the apron on in the cargo line.

An emergency response plan for spills and fire has been made for NEEM camp. This plan is available in the main dome (Field leader office and kitchen) and in the garage. Camp personnel should know the contents of this plan.

Quarterming and buildings



NEEM camp June 2009.

Until 11th May:

	PAX normal	Max.PAX	
Kitchen/office	5	12	40' wooden dome
Big tomato	1	2	Fiberglass dome
Small tomato	1	1	Fiberglass dome
Quarter	6	8	25' red dome
Quarter	6	8	20' red dome
Garage			26' x 40' Weatherport
Workshop			26' x 40' Weatherport
Total	19	31	

After 11th May:

Kitchen/office	5	12	40' wooden dome
Quarter	6	8	25' red dome
Quarter	6	8	20' red dome
Quarter	2	2	10' x 10' Weatherport
Quarter	2	4	12' x 20' Weatherport
Quarter	2	4	10' x 15' Weatherport
Quarter	2	4	10' x 15' Weatherport
Food Storage	1	2	12' x 20' Weatherport
Garage			26' x 40' Weatherport
Workshop			26' x 40' Weatherport
Big tomato	2	2	Fiberglass dome
Small tomato	1	1	Fiberglass dome
Total		29	47

All buildings are equipped with a 230V powerline capable of delivering 1 kW. If heaters are used, please limit the heating to just above freezing. In May and early June temperatures in the quarters will be below freezing. Beds will be either bunk beds with foam mattresses or foldable beds with a 5 or 10 cm foam mattress. Do not remove mattresses from empty beds!

Personal field equipment

All participants, except for those who have special arrangements with NEEM operations, are expected to provide their own polar field equipment and personal clothing, including normal winter garments, towels, toiletries, soap, facecloth, etc. A typical polar field bag should contain:

Polar Survival Kit

- 2 Woollen underwear, terry cloth, trousers and jacket
- 1 Fleeced trousers and jacket
- 1 Overall trousers
- 1 Polar boots, including extra liners, preferably 2 pairs.
- 3 LLB grey polar socks
- 1 LLB parka
- 1 Leather gloves
- 1 Thin inner gloves
- 1 Insulated leather gloves, or ski type gloves
- 1 *Mittens. Optional*
- 1 Dark sunglasses
- 1 Sleeping bag, -10 degC or lower
- 1 Fleece liner for sleeping bag
- 1 Balaklava cap
- 1 Ear gear, fleece or rubber.
- 1 Face mask, *optional, only for those involved in snowmobile traverses.*
- 1 Ear protectors
- 1 First Aid kit

Please bring also

- 1 Neck Tie or Dress
- 1 Solid hiking boots
- 1 A sturdy cup for coffee or tea
- 1 Your favourite cooking book
- 1 Your favourite music CD's
- 1 Your favourite game

The polar field bag must follow the individual. It is not permitted to board aircraft or engage in traverses without a suitable survival kit.

SITREP

The Field Leader will Sunday night prepare a **SITuation REPort** "SITREP", i.e. a report on the preceding week's field activity. This report will be transmitted by E-mail to the Copenhagen office. From here, it will be retyped and put on the NEEM home page for download and sent by e-mail on Monday the NEEM project group and the relevant Greenlandic and Danish authorities.

The Sitrep follows the following format:

1. Number, date and time
2. Passenger movements
3. Cargo movements
4. Camp activities
5. Sub programmes
6. Drill depth and time
7. Status for drilling
8. Other info
9. Signature of the Field Operations Manager

Daily report on the web (www.icecores.dk)

Daily a short "What we have done today" report and stories from the traverse & camps will be placed on the web. Information will be sent from the NEEM camp to the Field Operations Manager office in Kangerlussuaq that will take care of the home page. The Field Operations Manager (neem-fom@gfy.ku.dk) will coordinate this activity.

NEEM Official Address in Greenland

NEEM 2010
Box 12
DK-3910 Kangerlussuaq
Greenland
Phone +299 84 11 51; FOM cell +299 52 41 25
fax +299 84 12 27; e-mail: neem-fom@gfy.ku.dk

Terms of reference for the NEEM 2010 Field Season

During the field season J.P. Steffensen, Anders Svensson & Dorte Dahl-Jensen will be field leaders, having formal command & responsibility of operations.

Accidents and Illness

There will be a doctor in camp. In case of accidents or illness, the patients will first be given First Aid and if evacuation is needed an aeroplane will be called in from either Kangerlussuaq, East Greenland, Thule, Summit, Station Nord, etc. to transport the patient(s) to a suitable emergency site/hospital.

Good communication (Iridium, BGAN, Radio) and navigation equipment (GPS) should ensure fast evacuation if needed. Under most circumstances, we can move a patient to a hospital within 24 hours.

NEEM 2010 – Useful numbers

During the field season contact to the participants at the NEEM site can be made as described below:

Direct numbers to camp:

Iridium OpenPort telephones

+8816 (the numbers have not been issued yet. Please contact the NEEM FOM on numbers)

+8816

Only one of these numbers will be available at any given time. Please ask the Field Operations Manager which number is current.

Cost examples to or from OpenPort

Land line or Cell phone	\$1.20 per minute + line operator, up to \$10/minute
Iridium or Thuraya Voice	\$4.40 per minute
Global Star	\$6.26 per minute
Iridium to Iridium	\$0.60 per minute

Iridium Satellite telephones

+ 8816 414 39863

+ 8816 414 39864

+ 8816 214 64908

+ 8816 214 42402

Only some of these numbers will be available at any given time. Please ask the Field Operations Manager which number is current.

Cost examples to or from Iridium

Iridium to Iridium	\$0.65 per minute
Land line or Cell phone	\$1.20 per minute + line operator, up to \$10/minute
Thuraya Voice	\$4.40 per minute
Global Star	\$6.26 per minute

Initially **NO** external bell will be connected to the phones so arriving calls are not always heard.

Good times to call are during

Lunch 15:00 – 16:00 GMT

Evening dinner 21:00 – 22:00 GMT

The Iridium systems (OpenPort and hand-held) should be operational 24 hours. By February 2009 the Inmarsat satellites have been relocated, the system is not so reliable, but we have it in camp as back up.

The participants will have limited access to making the phone calls to limit costs.

EMAIL:

The Field Operations Manager will check arriving E-mail at least once a day on the following email: neem-fom@gfy.ku.dk. Don't forward large attached files.

On the ice we last year used the new Iridium OpenPort system to send & receive E-mails. As last year, we will have special computers set up for personal use for text messages. And we will be able to send & receive any E-mail via the address: neem-camp@gfy.ku.dk BUT at a high cost! PLEASE Remember to avoid surfing on the internet with a lot of banners and pictures, and avoid attaching image files. The field leader will send images for the NEEM diary on the NEEM home page every day on behalf of everybody.

Iridium OpenPort system

NEEM camp utilizes the Iridium OpenPort system. This system consists of an array of antennae and receivers that multiplex to obtain two ingoing phone lines and internet connection. This system was very stable in 2009. At NEEM there is a complete backup OpenPort system. While the Field Leader has unrestricted access to telephones and the internet, camp personnel are in general

Telephone Dialling

With the BGAN equipment is a standard phone which should be setup & ready to use. Just dial the number remembering all calls require the international dialling code i.e. +45 for Denmark, +1 for USA

Internet Connection

There will be e-mail possibility and limited internet connection in the 2010 field season.

A mix of wired LAN within the main dome & wireless LAN will be setup during the season. This will allow full access to all personnel of their email account, etc. BUT with a daily limit.

*** Please Note**

Using the internet is paid for per MBit. If unlimited, unnecessary uploads & downloads of software updates, large email attachments, images, movies, etc. by NEEM participants will very quickly cost the NEEM budget a fortune! Please, turn off all automatic downloads and all banners and pictures on your browser before connecting.

Personnel Transport 2010

The NEEM participants will deploy to Kangerlussuaq, Greenland via either Scotia AB (from the U.S. and Canada) or Kangerlussuaq (from Copenhagen). The transport to and from NEEM camp will be direct from/to Kangerlussuaq with a U.S. air force LC130.

During the stay in **Kangerlussuaq**, people will be billeted in Kangerlussuaq International Science Support (KISS). At KISS, all participants will be provided with bed linen but are responsible for cleaning their room.

Unless otherwise arranged, each nation takes care of tickets to/from Greenland for their participants. If troubles arise at making ticket reservations we should be notified. The increasing number of tourists travelling to Greenland results in a long waiting list, so please make the reservations as early as possible.

Note, unless arranged otherwise, each nation must take care of tickets and insurances of their own people.

People directly employed by NEEM receive a per diem to cover the cost of living according to Danish rules. In SFJ, the maximum per diem, which can be charged to the project, is 429 DK Kr per day. On the ice, the maximum per diem is 150 DK Kr per day. The actual per diem paid to the participants should follow the rules in each country, and the physical payment will be taken care of by each nation unless arranged otherwise.

Booze and Drugs

You can bring the following tax free to Greenland: 1 l hard booze (22% or more) and limited amounts of beer and wine. 400 cigarettes are allowed. In case you have not purchased the duty free items in Copenhagen, you can do it in Kangerlussuaq on the day of arrival, showing the boarding pass, and before you leave the secure area. The price of one beer in Greenland is approximately 20 DK Kr, one litre hard liqueur cost approximately 500 DK Kr.

People can bring their own prescription medicine. If prescription medicine is needed, make sure camp physician is informed. In case of illness, necessary drugs will be supplied by the camp physician. Greenland law forbids any import and consumption of drugs, such as cannabis, morphine and designer drugs. Any person who attempts to bring in or use illegal drugs in Greenland will be expelled from camp immediately and FOMs and Field Leader will contact Greenland police.

Welcome To The NEEM Camp



NEEM camp main street in August 2008 looking towards SW (photo: Tim Burton).



Neem Heavy vehicles on parade, July 2009

The living conditions on the ice cap are quite different from those back home, therefore we would like to tell you some simple rules to follow. Some of them are even new for old-timers.

- The ski-way area and apron are **off limits** unless approved by the Field Leader.
- When an aeroplane is expected, the Field Leader has assigned a person in charge of the apron activities. You are obliged to act as instructed by this person.
- Never leave the camp without informing somebody, the weather can change very quickly. If you go more than 2 km away from camp, the field leader should be informed. And remember to bring a PLB (Personal Locator Beacon). The Field Leader will hand out a PLB.
- The eating hours are (please be in time, to make it easy for the cook).
 - Breakfast is individual (normally between 7:00 and 8:00),
 - Lunch is at noon (13:00 on sundays),
 - Dinner is at 19:00. While eating outside of lunch and dinner hours, make sure that all plates, etc. are cleaned after use.

- Heavy vehicles and snow blowers are only operated by few people assigned by the Field Leader.
- Skidoos –
 - Everybody can use the skidoos when not in specific use, but please make sure that:
 - Drive slowly in camp.
 - Park the scooters with the gear in non-engaged position
 - Skidoos can only be removed from the camp area after an agreement with the Field Leader.
 - When attaching a sledge to a skidoo, always use the hook. Only connect the sledge with a rope if no other option exists, and keep the rope as short as possible.
 - Make sure the main drive belt is not frozen by wiggling the skidoo from side to side before start.
 - Only drive skidoos when necessary.
 - Do not drive in the clean zone, South and East of camp unless permitted by the Field Leader.
- Never leave any cargo at the surface without marking it with a bamboo pole, otherwise it may be lost due to snow drift over night. Roll up cargo straps and put them in designated piles.
- If you remove marked items on the snow, then also remove the bamboo marker in order to avoid disorder and digging for nothing.
- Drinking water originates from a marked area. So never drive or walk through this area or contaminate it with any body fluid. Just keep out of the marked area.
- Drinking water will be produced in the cooks snow melter. Refill it with snow from the marked area when there is room in the pot to keep a steady water supply in the camp.
- In order to keep the camp clean there are only a few bamboo poles where you are allowed to take a leak.
- During blizzards visibility goes down. If visibility becomes so poor, that you cannot see adjacent tents or buildings from where you are there is a serious risk of getting lost. **Stay inside where you are until you are picked up by a team from the main dome.**

Personal Locator Beacon (PLB).

A personal locator beacon, PLB, will be issued to anyone to has to leave camp. It is a unit with the size of a hand held radio. The unit is registered at the radio authority of Greenland. When activated, the unit contacts a satellite with a distress signal. The unit transmits it's identity code and it's GPS position (it has a built in GPS). The radio authority will contact the NEEM FOM with specifics of identity and position.

Power Supply

Within all operations during NEEM 2009 230 Volts, 50Hz will be the standard supply. The whole camp will be powered by the main generator. For projects away from camp, such as firm air pumping and shallow coring, we will use diesel generators where possible to conserve mogas.

Some U.S. teams will be using 115V, and camp will supply a 230V to 115V voltage transformer.

Diesel

1 – Iveco	125KVA	3 x 230V (400V/50Hz)	Main generator.
1 – Mase	16KVA	3 x 230V (400V/50Hz)	2nd backup
1 – SDMO	15KVA	3 x 230V (400V/50Hz)	1st backup
2 – Hatz	5 KVA	1 x 230V / 50Hz	available

If necessary, one Hatz Gen. Sets can be fitted with a 6.8KVA 3 phase (400V/50Hz) alternator.

MoGas

1 – Honda	4.5KVA	1 x 230V / 50Hz
1 – Robin	4KVA	1 x 230V / 50Hz

In order to provide a base load, all weatherports are supplied with electric heaters. These heaters should be set at lowest power output at all times. The heaters are installed to keep the weatherports dry and relatively frost free, and NOT to create room temperatures inside.

Please help to conserve fuel by conserving power.

Assigned Duties

Everybody in camp will be assigned extra duties on a rotary basis. These duties include:

Cooking. Although there will be a cook and a cooks helper in camp, Saturday night dinners are prepared by the camp crew. Sunday morning breakfast is self service. If you skip meals, please inform the cook(s) in advance.

The field Leader will make a roster with rotating duties on the following:

Dishwashing. We expect all to help keeping the dishwashing an easy duty.

Snowmelter. Although one person is assigned, everybody has the duty to keep the snowmelter full. Check the water level before and after you have taken a shower and after doing laundry.

Drinking water snow melter. Each day one person is assigned to be responsible for keeping the drinking water snowmelter full. Use ONLY the assigned buckets and showels and take ONLY snow at the assigned spot. Hygeine is very important.

House mouse duty. One person will be assigned to keep toilets and common areas in the main dome clean

Maps of the NEEM camp area and layout

On the following three pages are maps of the NEEM camp and Science areas in different scales.

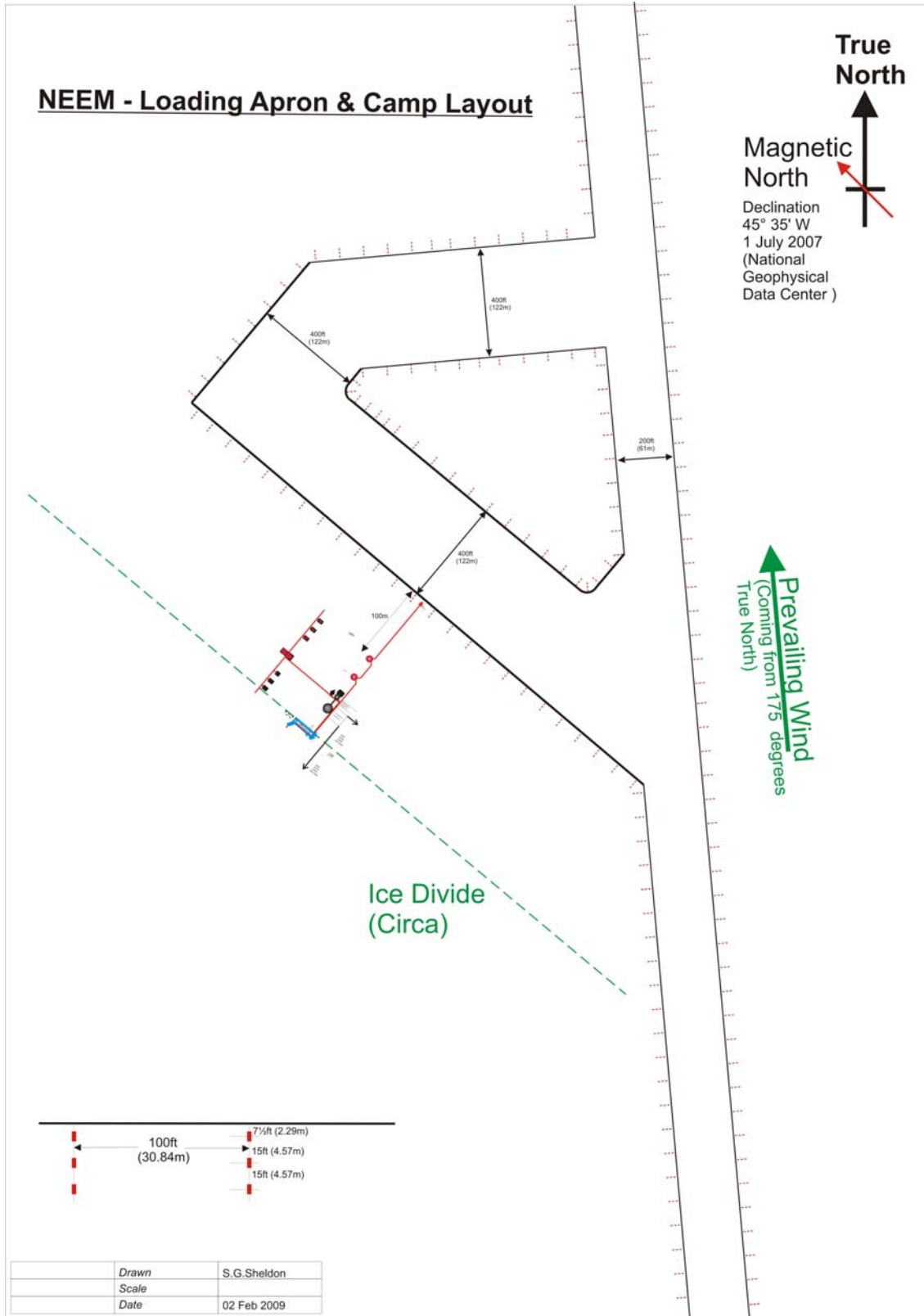

NEEM Drill Trench & Science Trench

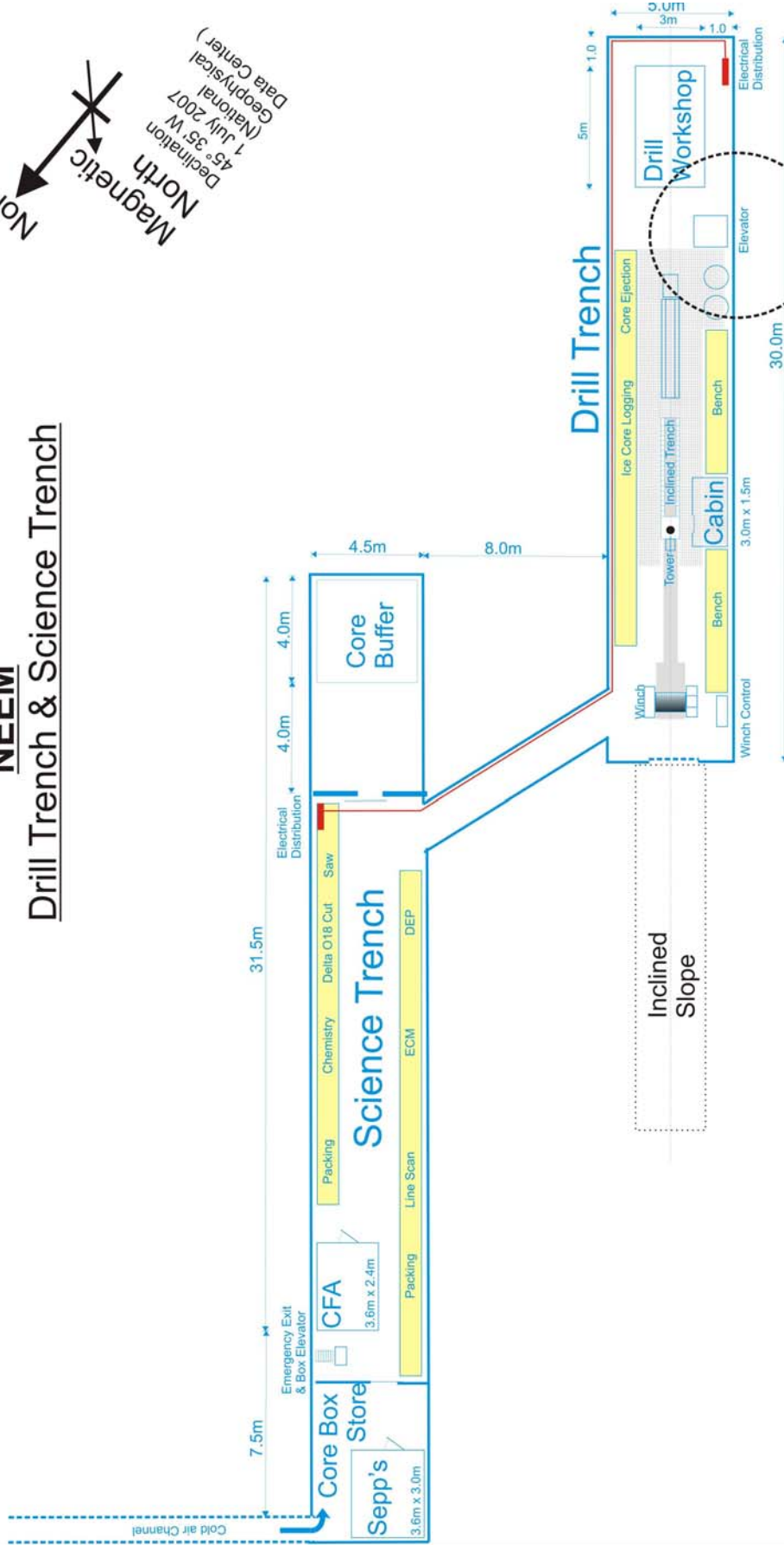
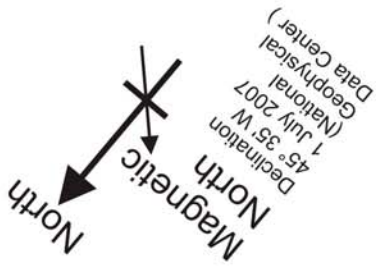

21 foot White
Dome on Surface

Drawn	S.G.Sheldon
Date	25 March 2007

Skiway Marking:

NEEM ski way will be 200' x 12.000' (Feet)
 Skiway design from AFI 13 – 217, 10.MAY 2007

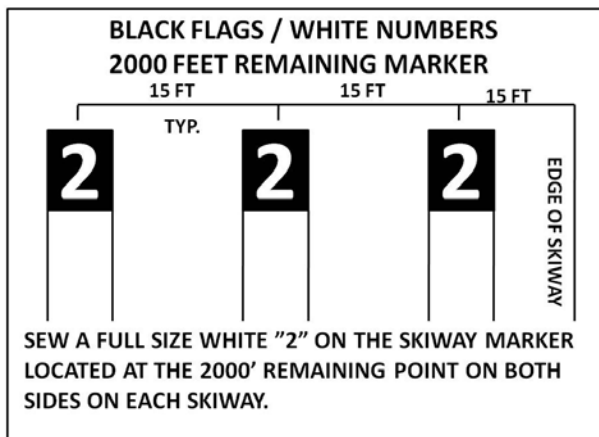
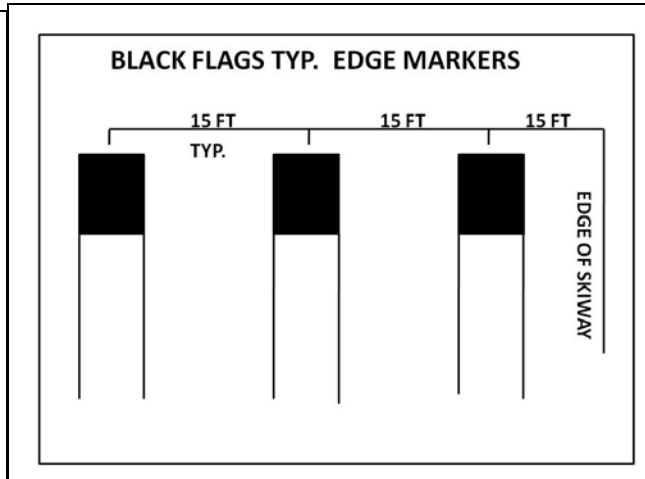
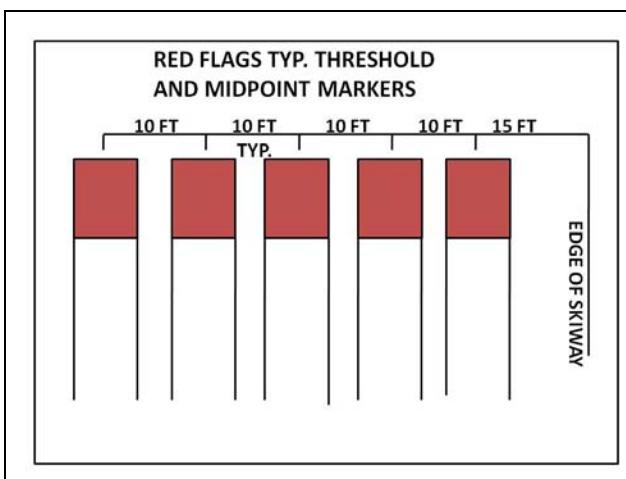
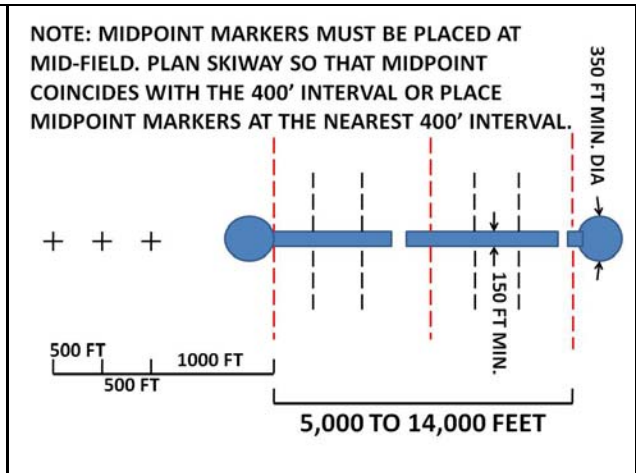
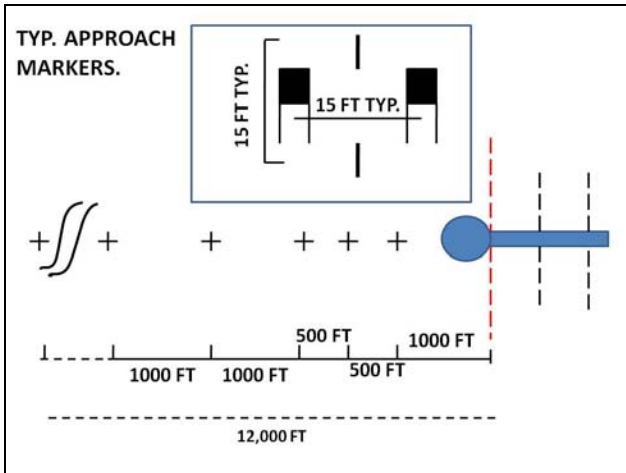

NEEM weather conditions 2006 - 2009

The NEEM weather station was in operation throughout the 2009 season. Below are histograms on the statistics. For comparison, Dorthes summary on weather at NEEM in earlier seasons is included.

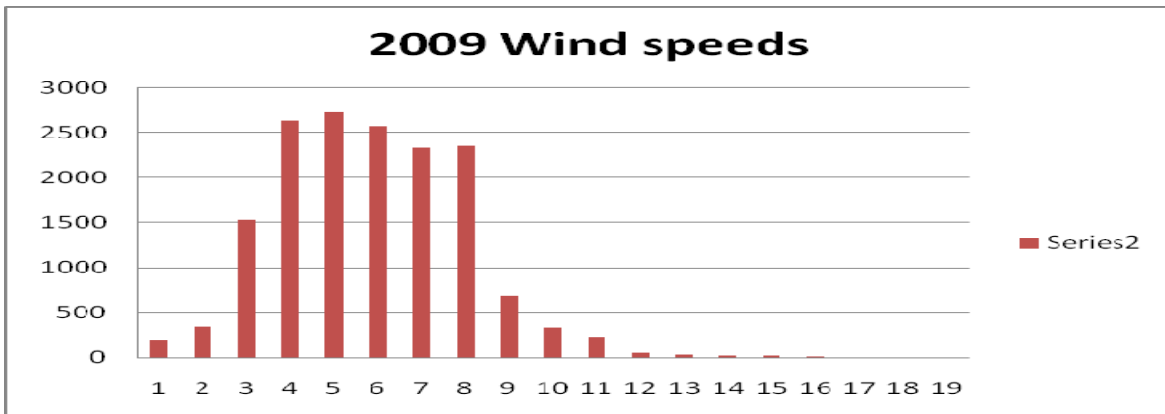

Wind speeds are in m/s. The ordinate is number of observations. A total of more than 16,000 were logged with a 15 min time interval.

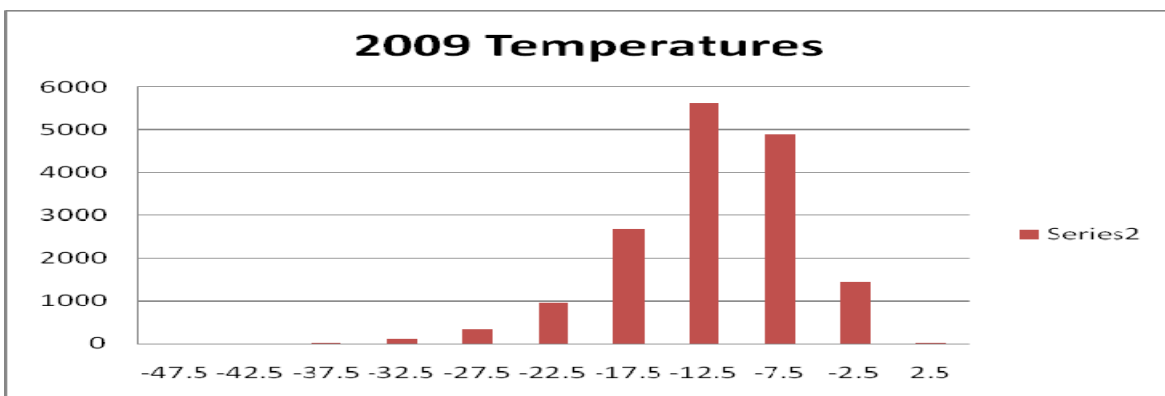
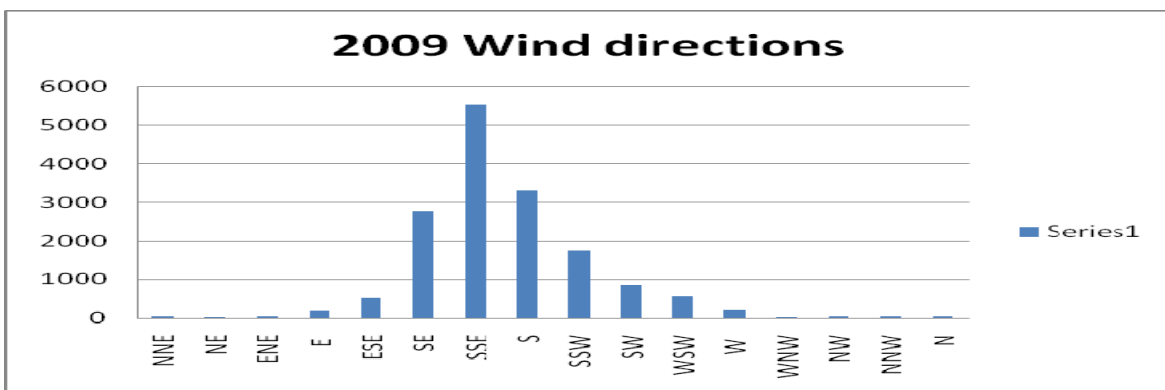

NEEM temperatures in 5 degree intervals.

Earlier years:

In 2008 the data from the NEEM weather station has been downloaded since 4 July. The wind directions are only logged in 16 boxes (N,NNE,NE, ENE,E,ESE,SE,S,SSW,SW,WSW,W, WNW,NW,NNW) in Magnetic Values. (declination is appr. 45 deg so True = Magnetic-45)

The PARCA weatherstation was downloaded 7 August 2008.

In the analyses the value of wind direction sensor that agrees with the NEEM weather station has been used. (PARCA 1, black)

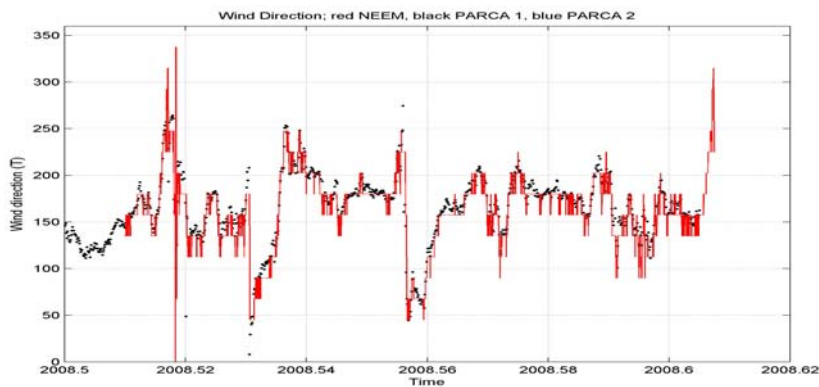
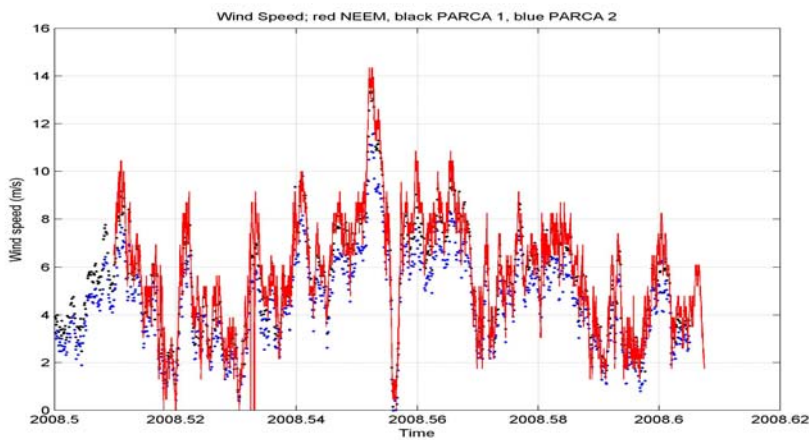
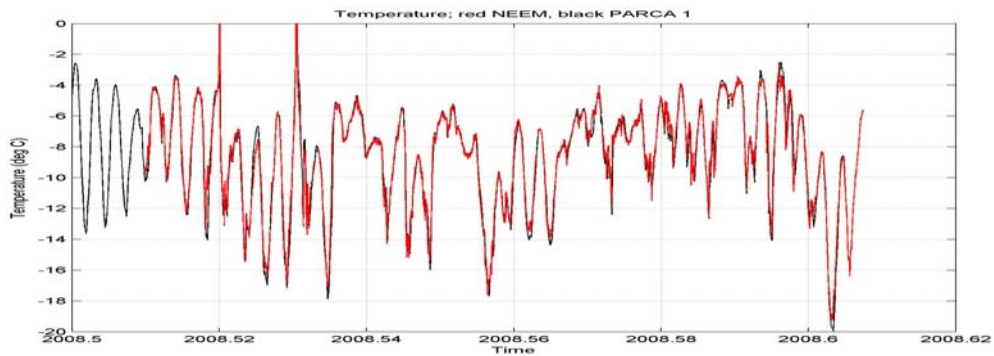

An interesting aspect for us is the wind speed and direction both for flight operation but certainly also for interpretation of the climatic parameters we observe in the ice core.

A wind rose shows that the wind directions have been the same during 2006-2008

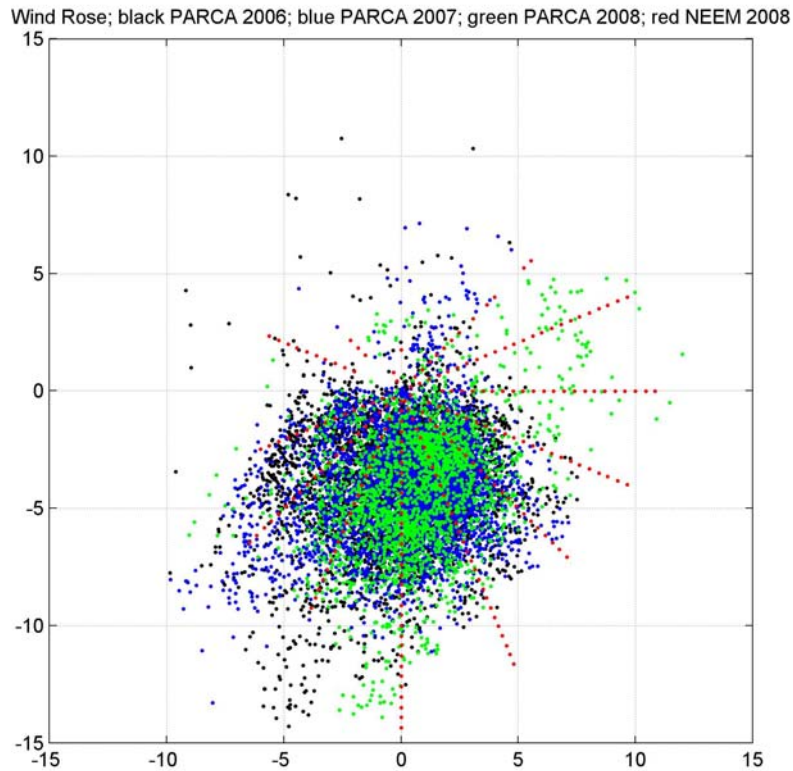

In the wind rose speeds are in m/s and directions in True degrees. It can be seen that the prevailing wind direction is around 180T with a tendency to turn to the west when the winds are strong. The NEEM data are not easily plotted this way because there only are 16 directions. It is thus not possible to see the frequency of the directions because they are just plotted on top of each other.

I have tried to make some statistics on the directions by drawing 3 data sets out for the 3 years observed. For each of the years I have made histograms of all the data, the data where the wind speed has been stronger than 5 m/s and finally the data where the wind has been stronger than 10m/s.

It can be noted that when the winds are stronger than 10 m/s the skiers rarely land in the camp.

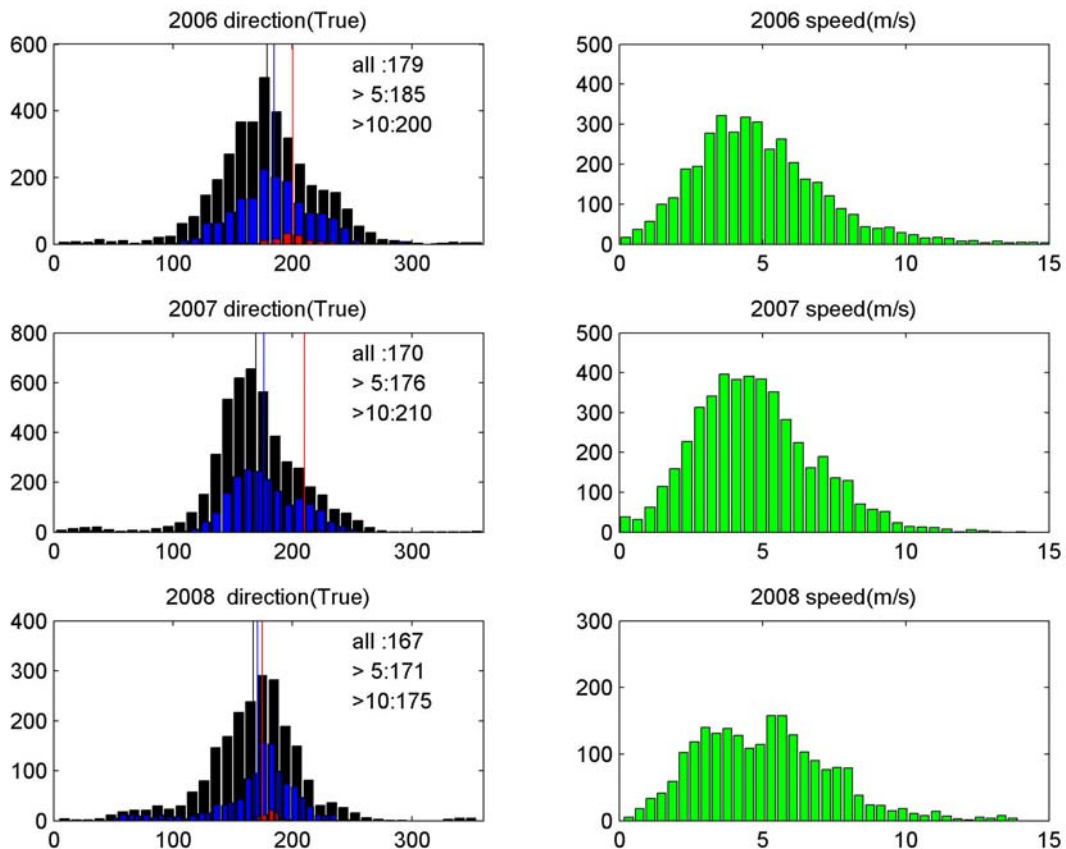

It can be seen from the histograms that the mean wind direction through the summer months has been between 167T and 179T. When the wind is strong the direction changes slightly to the west. This is not so pronounced in 2008 mainly because there has been strong winds from many different directions. It can also be noted that 2008 has been a windy year (as we know...)

From these observations it is concluded that the prevailing wind direction is 180T (the average has been twisted towards the stronger winds) which is in disagreement with the value reported from the PARCA weatherstation based on the 2006 data (132T). I have been in contact with Koni Steffen and they conclude that the magnets on the weatherstation have been mounted incorrectly and the results they had produced based on the wind direction sensor 2 where faulty.

Dorthe, 9 August 2008

Status of the Closed NGRIP Camp

The camp was closed in 2004. The only building left is the Main Dome . The camp was revisited in 2007 and 2008, where access through the top window of the main dome was still possible.



NGRIP, July 2007, View from Lucht Kastel. Main dome and hole casing to the right, 32 drum fuel depot on old apron in background

Main Dome (75.0977N, 42.3195W):

Only accessible through top window. The traverse team removed most usable items in 2008.

Former site of The Lucht Kastel:

(75.0991N, 42.3208W): Everything was removed by the traverse in 2008.



The Lucht Kastel. Middle just before closing in 2007..

The NGRIP2 Deep Borehole:

(75.0970N, 42.3196W): The casing has been extended and runs roughly 5 m above the snow.

Kangerlussuaq and Surrounding Area

In terms of complexity, Kangerlussuaq (Søndre Strømfjord or SFJ) is unique. There is no native village. The first settlement was the US base Blue West Eight during World War II. The base was closed October 1, 1992, and all facilities handed over to the Greenland Home Rule. Due to its US origin, the main electrical supply in Kangerlussuaq is 60 Hz, and you may encounter both 115V and 208V US type sockets, as well as 230V Danish sockets.

The population is approximately 550 including many kids. The terminal area is composed of several businesses: Met office, Flight control, SAS, Local supermarket, Some souvenir shops, a road side grill, Air Greenland and Statoil. The terminal side includes private housing, a combination of Air Greenland terminal and Hotel Kangerlussuaq, which also houses the GLAIR offices and pay phones. There are also buildings to the west of the terminal which house the Airport Administration and Spedition (where outgoing and incoming cargo between Denmark and points in Greenland can be sent and received). The Greenlandic Post Office is located next to the local supermarket.

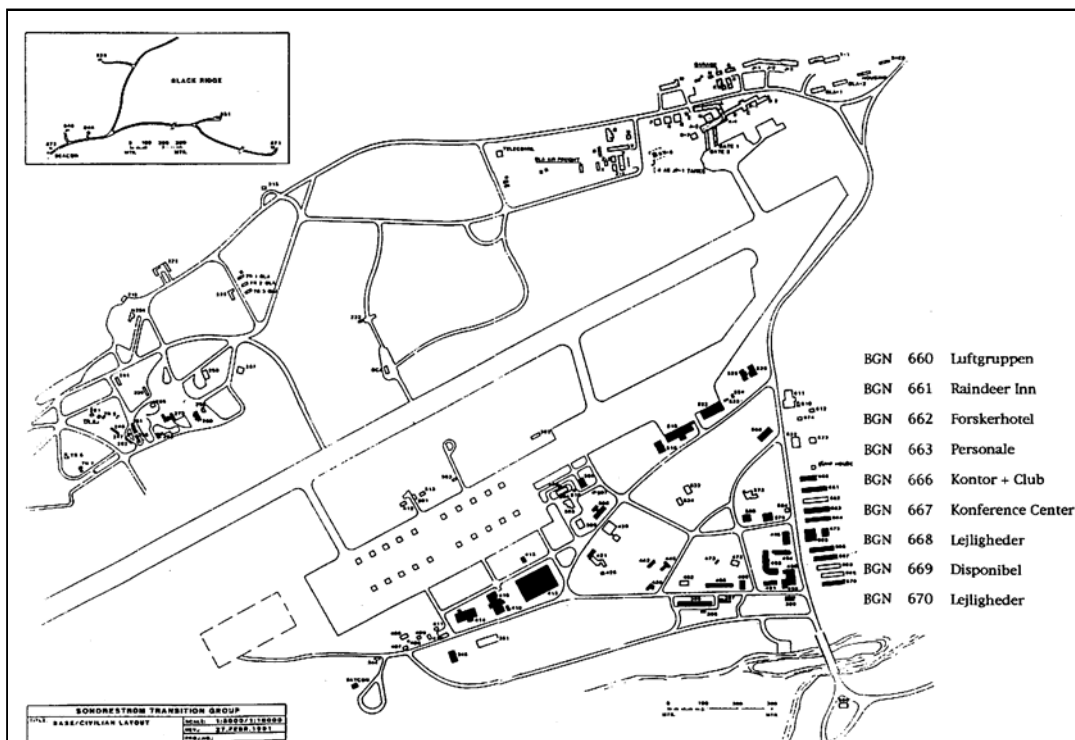

Weather: The climate is continental and quite xeric with an annual precipitation averaging 120mm.; winter temperatures reach down to -50°C and the summer temperature increases to above $+20^{\circ}\text{C}$. In project planning for fieldwork in or around Kangerlussuaq, it is always best to prepare for the worst. The weather in Kangerlussuaq can be cold in May, and snow is always a

possibility. June, July and August are normally fairly temperate with temperatures ranging from 5-21°C. Rain is rare in these months, but given the right conditions, it can still be quite cool.

Field clothing should include windbreaker, rain wear, work boots, warm hats and gloves, woollen shirts, sweaters and trousers. Given the wide range of temperatures during summer months, the use of layered clothing offers the greatest flexibility.

Another important consideration is the insect season, normally from first week of June to late July. During this period, large, voracious Arctic mosquitoes are abundant.

Kangerlussuaq is the main hub for air traffic to and within Greenland with regular direct international connections to and from Copenhagen (Denmark) and occasionally Keflavik (Iceland).

In Kangerlussuaq you can buy regular, canned or freeze-dried foods, fuels (jet fuel/kerosene, gasoline, and field stove alcohol). There is also a post office, an airport hotel with restaurant and cafeteria, a gym centre with swimming pool, a tennis-, badminton-, racket ball- and soft ball court, a golf course - and also a small museum with exhibitions about the history of Kangerlussuaq. Check www.greenland-guide.gl for information.

There are a few alternative dining and drinking establishments in Kangerlussuaq. The Roklub at Lake Ferguson is sometimes open in summertime and offers informal dinners at reasonable prices although the quality is varying. In the old dining hall, 100 m from KISS there is a small shop, a bar and restaurant "Nordlyset". Dining is available at the terminal. There is a cafeteria where the price of a typical meal is DK Kr.75. The restaurant at the airport can be used for formal dinners, and the prices are reasonable.

BASE FOR SCIENCE

Kangerlussuaq has a long tradition as an important base for field geophysical and glaciological research projects, but so far the region has had only limited activities within the disciplines of life science. The area lies at the edge of the Polar Cap Zone and the Aurora Zone. It is therefore of particular interest to science studies related to the ionosphere and the magnetosphere as well as to the lower and upper atmosphere.

The Kangerlussuaq region is within the low Arctic eco zone with diverse habitats like salt lakes, dune systems, mountain tundra and steppes with caribou and musk ox populations etc. Reindeer are indigenous but muskoxen were introduced from Northeast Greenland forty years ago. Muskox and reindeer are hunted and in season meat can be purchased at authorized butchers.

The plant growing season is long, featuring 150 days without snow cover, 80 continuously frost-free days, and 150 consecutive days with maximum air temperature continuously above freezing; (the numbers given are average values). The climate is very stable and with low rate of rainy days. The monthly mean is 241 sun hours in May through August.

The Kangerlussuaq region is a well exposed high grade basement terrain forming the southern border zone of the Nagssugtoqidian orogen. The region has a glacial landscape dating back 8,000 years. The town is sitting on uplifted fjord sediments that popped up due to isostatic rebound

after the last glacial. You may find proto-fossilized fish in the sediments west of town. Please note: It has become illegal to take large amount of fossils and rocks out of Greenland. As a rule of thumb, you are allowed to take out what you can have in a closed fist.

The proximity of the Inland Ice has a significant effect on the climatic regime for the living resources and further it presents unique logistic opportunities for studies on the Ice Sheet proper, the edge zone, and periglacial geomorphology.

The KISS (Kangerlussuaq International Science Support) facility

Scientists and students who plan to work in Greenland have facilities available in Kangerlussuaq. KISS offers an array of modern facilities and possibilities to rent equipment and goods for use in the field or at the labs of the KISS building.

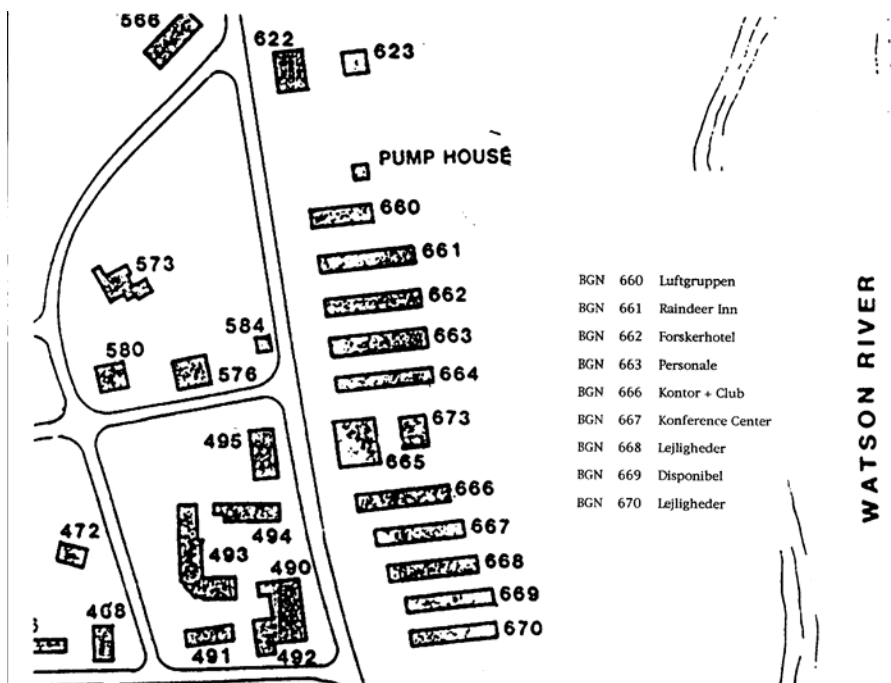

KISS (bldg. 662 in the map) is owned by the Home Rule Government and operated by the Kangerlussuaq Airport Management. The use of KISS is reserved exclusively for researchers and research projects registered by the Greenland Authorities after submission of project plans.

It is important to realise that KISS is a year-round facility and that the Kangerlussuaq region offers obvious research opportunities and potentials during the 8 winter months. This applies both to projects in biology and geophysics and the presence of KISS now greatly improves the logistics for performing field operations during winter time

The KISS facility, and the other facilities in Kangerlussuaq offer unique possibilities for performing science based at Kangerlussuaq. Please contact the NEEM FOM office for more information.



Thule Air Base

BE AWARE THAT.....

- Thule AB is UTC-4(DT-3). DT from 0600 UTC first Sunday in Apr to 0500 UTC last Sunday Oct.
- operating hours are as follows:
 ATC: Mon thru Fri 0800 -1600
 Base Ops: Mon thru Friday 0800- 1600.
 Services: Mon thru Friday 0800- 1600
- The Airport is closed on Saturdays, Sundays and US holidays.
- Moving of aircraft, start- up of APU/GTC, or engine -runs will be coordinated through Base Ops

STORM ALERT CONDITION: Severe weather is forecasted.

Take all necessary preparatory action, tie down loose equipment, check emergency rations, pass the word to all personnel.

STORM ONE CONDITION:

Alerted for possible Storm Two or Three. Pedestrian traffic LAW the Buddy System only.

STORM TWO CONDITION:

Return to your living quarters. No pedestrian traffic allowed. Dining Hall and community facilities closed. Critical functions continue limited operation as approved by Crisis Action Center (CAC).

STORM THREE CONDITION:

Remain where you are. Required emergency or rescue traffic only, as approved by CAC.

Useful Telephone numbers at Thule AB, Duty/Home

Commander	2311/2311	Hangar #8	2695
Operations Officer	2750/275	Hangar #9	2304
Flightline Superintendent	2503/2149	Hangar #10	2712
Air Terminal Supervisor	3227/3227	Security Police Desk Sgt.	3234
Transient Alert Supervisor 3344	2356/2167	Message Center	
Base Operations Dispatch	2717	TOW Club Paging/Taxi	2418
Passenger Service	2155	Club Reservations	3118
AMC Traffic Control	2455	Weather Forecast	2395
Fuels Management	2553	Service Call	2111
Crew Transport	3284	Hospital Ward	2877
Flightline Standby	3284	Crisis Action Center	2763
Taxi (Free)	2022	Telephone Information	113
Base Housing	3276	Inflight Lunches (3 hrs notice)	2101
Base Operator	0	Fire Reporting and Ambulance	117

Hours of operation

Dining Hall	Ext. 2614	TOW Club (Casual Lounge)	Ext. 2418
Breakfast	0500-0800	Monday	Closed
Lunch	1100-1300	Tue thru Thursday	1100-2300
Dinner	1700-1900	Friday & Saturday	1100-0200
Community Activity Center	Ext. 3171	TOW Club (Dining Room)	Ext. 3118
Mon-Tue & Thursday	1500-2100	Monday	Closed
Friday	1500-2200	Tue-Friday	1800-2100
Sat & Sunday	1300-2200	Saturday	1900-2200
Hobby Shop	Ext.2228		
Mon, Thurs & Friday	1600-2100		
Tue-Wednesday	Closed		
Sat & Sunday	1200-2000		
Bowling Center Ext. 2435			
Mon & Wednesday	Closed		
Tue & Thursday	1700-2200		
Friday	1300-2300		
Saturday	1200-2300		
Sunday	1200-2100		
Base Exchange (BX)			
Mon thru Friday	1030-1330 1600-2000		
Saturday	1000-1600		
Base Gym	Ext. 2519		
Mon thru Friday	1000-2200		
Sat & Sunday	1000-1900		

Other useful information for Thule Passengers

There are only a few civilian phones in Thule. If you want to phone out of Thule, there is a pay phone at North Star Inn. Remember to bring Danish Currency! The normal currency in Thule is US\$, but for letters going to Denmark/EU and phones you will need Danish currency.

We, NEEM Operations, have no representation in Thule. If a NEEM operated plane have to land at Thule, our contact person is the DPI, Insp. John H. Hansen.

Phone Contacts can be made to the following phone numbers:

DLO	+299 97 65 26
DLO, fax	+299 97 67 26
DLO, Email	fotab@greennet.gl
Danish Spedition, phone	+299 97 66 69 or Ext. 2704
Danish Spedition, Mobile	+299 594495
Danish Spedition, Fax	+299 97 65 74
Danish Spedition, Email	kin@tele.gl
Warehouse 628	+299 97 66 06 Ext. 3643
Housing	+299 97 66 06 Ext.
North Star Inn/Billeting	+299 97 65 06 ext. 2272 / 3276
Air Greenland	+299 97 65 77 or Ext 3340
DK Police	+299 97 65 22 or Ext. 2406
DK Police cell	+299 594122
DK Police, Fax	+299 97 65 00

-

Cargo shipments to Greenland

NEEM will have a Field Operations Manager in Kangerlussuaq at all times this season. It is essential that all shipments are labelled correctly, and that NEEM is informed about every shipment. In addition, we can expect delays in the SAS and Air Greenland transport from Copenhagen to Kangerlussuaq although Air Greenland/SAS has now increased the number of flights.

Cargo to Kangerlussuaq should be labelled:

NEEM Operations 2009
Box 12
DK-3910 Kangerlussuaq
Phone +299 84 11 51. Fax +299 84 12 27
Greenland

The international designation of Kangerlussuaq is SFJ (Søndre Strømfjord)

We would like following information about each collo:

Weight

Dimensions

Volume.

Additional information and labeling

Non Freeze

Hold in Kangerlussuaq

Hazardous Material

Information on shipments and Air Way Bill # (AWB) should be emailed to:

neem-fom@gfy.ku.dk

We urge people to ship cargo as early as possible. Based on our experience and this year available air cargo space to Greenland we as a minimum recommend following:

SHIPPING DEADLINES

Cargo for NEEM April 27, Must **arrive** Kangerlussuaq(SFJ) latest **APRIL 19**

Cargo for NEEM May 11 - May 13, Must **arrive** Kangerlussuaq(SFJ) latest **MAY 4.**

Cargo for NEEM June 3, Must **arrive** Kangerlussuaq(SFJ) latest **MAY 25.**

Cargo for NEEM June 21 - June 29, Must **arrive** Kangerlussuaq(SFJ) latest **JUNE 15.**

Cargo for NEEM July 20 - July 28, Must **arrive** Kangerlussuaq(SFJ) latest **JULY 15.**

Cargo for NEEM August 17, Must **arrive** Kangerlussuaq(SFJ) latest **AUGUST 10.**

Shipping to NEEM from the United States/Canada

CPS POLAR FIELD SERVICES Polar Resources and the NEEM FOM must be notified of all cargo shipments, including commercial air in order to arrange for the receipt and transportation of cargo to the appropriate location in Greenland.

PLEASE NOTE: Be sure to mark your cargo with "NEEM 2008" to avoid your cargo ending up at Summit!

CPS POLAR FIELD SERVICES contacts: Robin Abbott (robin@polarfield.com) and Earl Vaughn (Earl.Vaughn@gmail.com)

It is necessary for you to enter your shipment into the CPS cargo tracking system (CTS). Robin Abbott will provide you with a password and login. You will receive an email from us when we have received your cargo in good order in Kangerlussuaq.

Below are the instructions provided to us by CPS Polar Field Services.

U.S. CUSTOMS INFORMATION - 2009

A Certificate of Registration (form CBP-4455) is required when shipping your cargo to Greenland via the 109th Air Guard. You can access these forms on-line so please follow the directions below.

STEP 1:

Go to US Customs & Border Protection website: < <http://www.cbp.gov/xp/cgov/toolbox/forms/> >
 Scroll down to "CBP form 4455" and open it up.

You can then fill out the form on line and print. You will need 4 copies.

Information to include in the following blocks:

- Carrier:** - 109 Air National Guard
- Date:** - current date
- Name, address and zip code:** - 'you' the shipper
- Articles exported for:** - science use in Greenland
- Number packages:** - whatever the number (must be identifiable on each item)
You do not need to certify personal clothing or food
- Kind of packages:** - hardigs, steel boxes, aluminum poles, wooden crate, whatever?
- Description:** - type in: "**see following (#) pages**" and attach your packing list to each 4455 Form. The numbered boxes should correspond to the shipping information.
 - The customs agent will inspect the contents of all or some of your boxes and check your corresponding packing list for accuracy

Sign and date

STEP 2 :

Call your local Customs and Border Protection Office (airports, harbors) and ask them to inspect and certify your cargo for shipment to Greenland. They will then schedule a time to look at your freight. After they do so, they will sign the Certificate of Registration form that you filled out and stamp all the copies of your registration and packing list. They will then keep a copy, and you should then

include one copy along with your cargo, send one copy to Earl Vaughn, and keep one for yourself. Your cargo is then ready to ship to Scotia. **If you cannot get the cargo inspected and Registration signed at your location, then send the four completed and signed documents to the address below and the inspection will then take place in Scotia. Your cargo MUST arrive 2-3 week prior to your scheduled flight.**

The Certificate of Registration and packing lists will be all you will need to bring the cargo back into the country through any airport or terminal.

You also might consider filling out the CBP 4457 for your personal gear. It will also need to be inspected and paperwork stamped. It will eliminate any questions or problems with your gear or expensive equipment such as computers, electronic gadgets, etc. These two forms act like a visa for your equipment. It also eliminates the need for filing electronic Shipper's Declaration for equipment. If you have any questions please call or write Earl Vaughn (info below).

Earl Vaughn
VPR Scotia Bldg. 20
1 Air National Guard Rd.
Scotia New York 12302
518-331-3103

Earl.Vaughn@gmail.com

Address of the 109th:

109th Airlift Group
New York Air National Guard
Stratton Air National Guard Base,
1 Air National Guard Rd.
Scotia, New York 12302-9752

Ship connections to Kangerlussuaq (2010):

Ship 1: Cargo in Aalborg May 20 to June 3
depart AAL June 4,
arrive SFJ June 14 (available June 20).

Ship 2: Cargo in Aalborg August 21 to August 28
depart AAL Aug 30.
arrive SFJ Sept. 16.

NEEM Drilling Liquid Properties

A new drilling liquid has been developed for NEEM based on ESTISOL 240 (coconut oil extract) mixed with COASOL. This liquid is non-polar, non-hazardous, no explosive risk, 'healthy', has a low environmental impact, and is available. BUT is twice the price of D-40/HCFE-141b and has 5 times the viscosity at -30°C.

TABLE .	<u>COASOL</u>	<u>ESTISOL 240</u>
Manufacturer	DOW	DOW
Melting point	< - 60 °C	< -50 °C
Boiling point	274 - 289 °C	255 - 290 °C
Flash point	131 °C	136 °C
Explosive limit	0.6 – 4.7 % (vol)	None
Vapour pressure (20°C)	0.004 kPa	
Density (20°C)	960 kg/m ³	863 kg/m ³
Density (-30°C)	995 kg/m ³	898 kg/m ³
Viscosity (20°C)	5.3 cSt	3 cSt
Viscosity (-30°C)	25 cSt	13 cSt
Auto ignition temperature	400 °C	None
Bio-degradable	Yes	Yes
Fire fighting equipment	Water spray, foam, CO ²	Water spray, CO ² , foam, dry chemical
Special protection	No	No
Hazardous material	No	No
Explosive risk	None	None
Max. Workplace air levels	None	None
Price US\$ equiv. in Kg	5.50 \$/Kg	4.60 \$/Kg

Data on ESTISOL 240, 256, EGDA, & COASOL are from safety tests according to EU Safety 91/155/EU, article 204020, 203989, 205698 & 204872 respectively

ESTISOL 240 was field tested as a drilling liquid at Flade Isblink, Greenland 2006 with a 4" diameter ice core drilled using the Hans Tausen electro-mechanical drill to a depth of 423.30m (260m of this core using the new liquid). The ice core quality was 'good', no problems encountered cleaning and processing the ice core, the mixture has a slippery feel with no discernable odour, and the liquid is very slippery when spilt on the smooth wooden flooring. The Hans Tausen drill descends at speeds of 0.95m/s at drill liquid temperatures of -16 deg. C. By increasing the borehole diameter by 4mm (to 134mm) a 36% descent speed increase was achieved (1.28m/s). Further improvements can be achieved by adding a dead weight, reducing the pressure chamber diameter, or reducing the pressure chamber length.

The mix proportions for the first 1000m are expected to be approximately,
 4 litre ESTISOL 1 litre COASOL

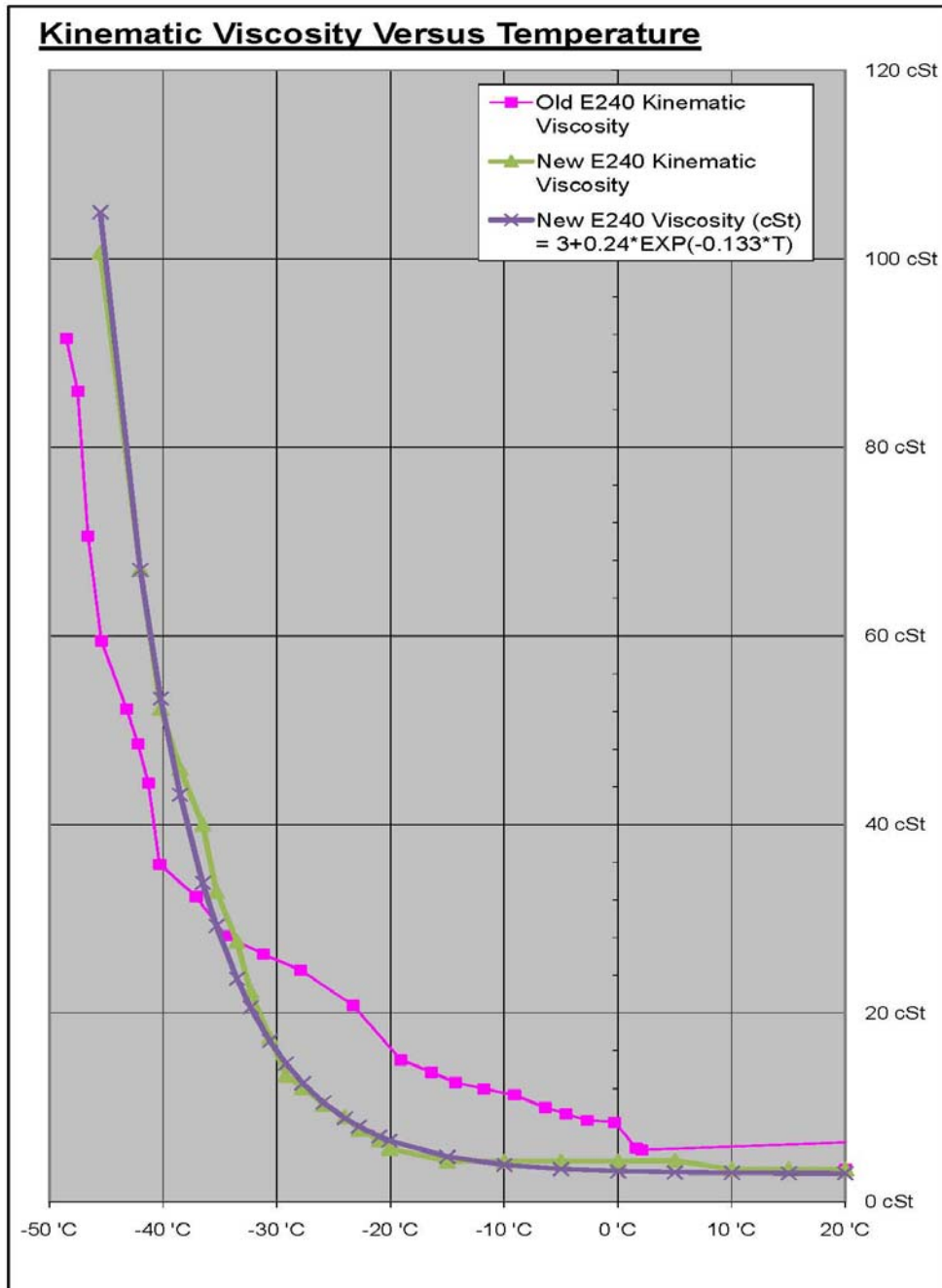

In February 2008, the supplier of Estisol 240 announced a change in specifications of the fluid due to a change in raw materials for the production (coconut oil has become too expensive) We therefore conducted a new set of measurements. As seen above, by cheer luck, this change has improved the fluid for our use. Purple: old Estisol 240; Green: New Estosol 240. Blue: simple model of kinematic viscosity vs. temperature.

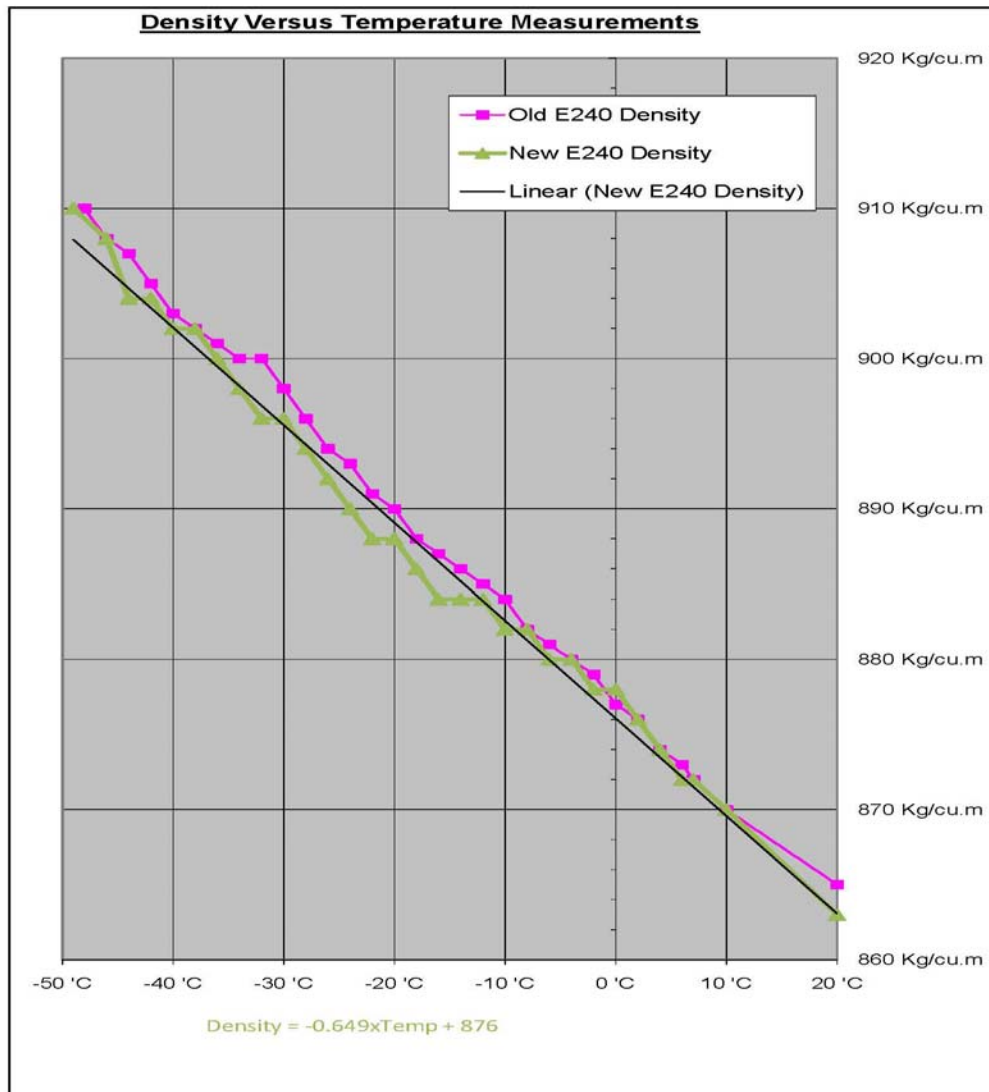

As seen above, the densities of new and old Estisol 240 are comparable.

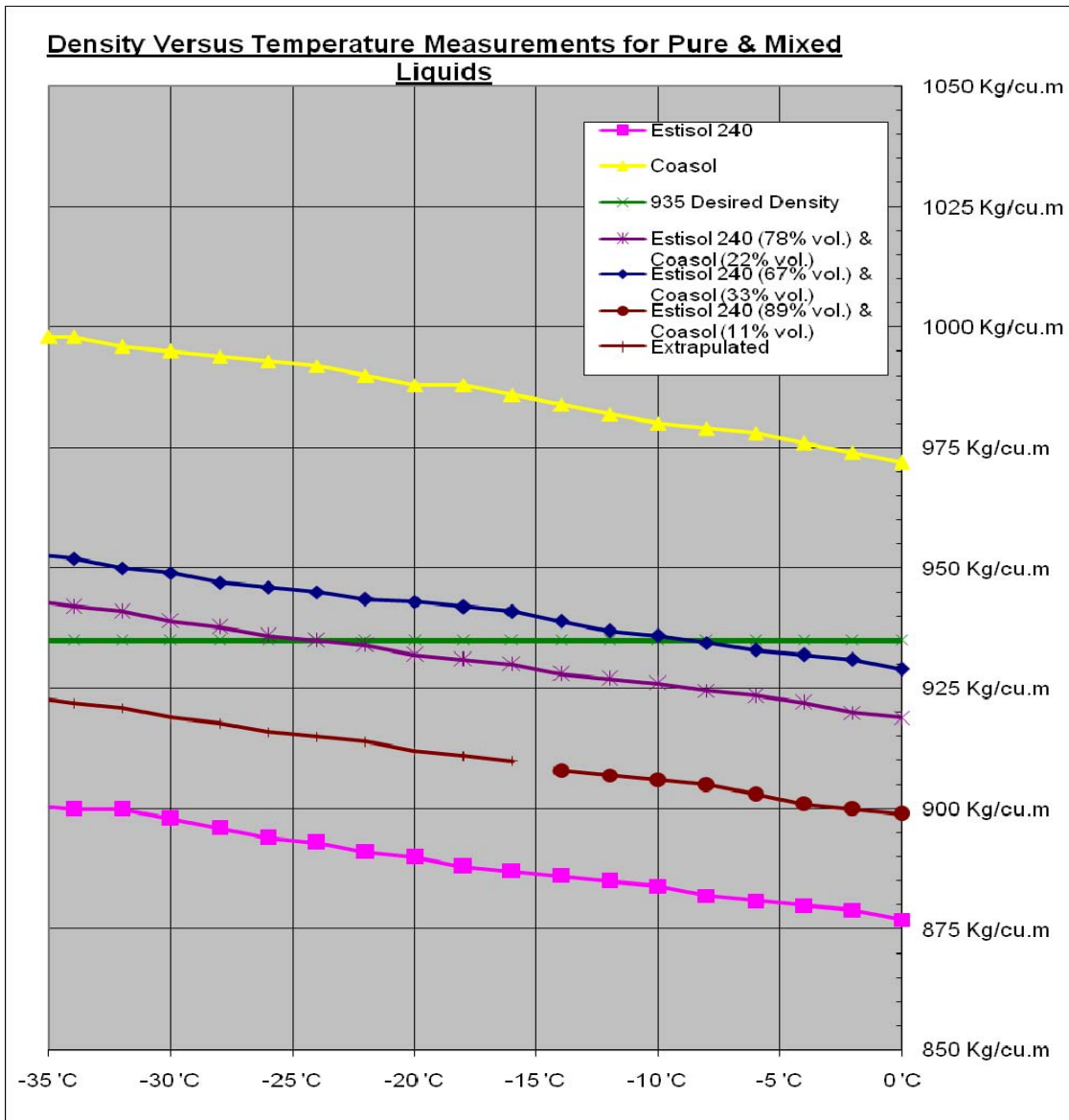

Above - density versus temperature of the drilling liquids in pure & in different mixes.

Fig. 1. Freezing points of alcohol aqueous solutions

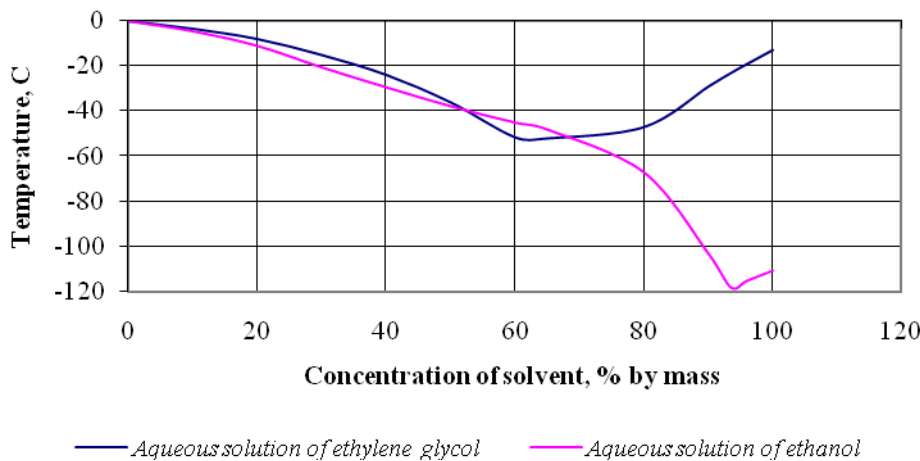

Shipping boxes

The type of shipping box is very critical for both the protection of the cargo, and for efficient air transport. In Kangerlussuaq, the boxes will be stored on the cargo line which is exposed to snow, rain, sand and wind. On the ice, drifting snow will creep through any openings. The off loading from the aircraft at Summit is in the form of drifting cargo: The pallets are slid down the rear ramp of the aircraft while the aircraft is taxiing. In order to obtain the full payload and prevent the aircraft from cubing out before reaching maximum weight, the boxes should be stackable on an Air Force pallet. Also, wooden boxes with nails sticking out are dangerous to handle. By experience, we have found the following series of boxes to satisfy all the requirements:

Zarges aluminium box, type K-470. The following sizes are preferred:

order nr	Internal dimens (L*W*H)	Outside dimens	Weight
40678	550*350*310	600*400*340	5,0
40564	550*350*380	600*400*410	5,3
40565	750*550*380	800*600*410	10,0
40566	750*550*580	800*600*610	12,0
40580	1150*750*480	1200*800*510	20,0

The boxes should be lined with a shock absorbing layer. We have found a 27mm layer of Dow Chemical EDPM foam, 35kg/m³, to provide the needed protection for even fragile material. Finally, in order to seal the box, all seams (bottom inside and outside, two vertical seams) should be sealed with Loctite 290 penetrating sealing compound.

For NEEM operations proposes, whenever possible, all participants use these or compatible boxes for their cargo. In order to be compatible, a box should have the same outside dimensions, and the same type of inter-box locking mechanism. The boxes should be equipped with handles.

The costs of transporting boxes are considered to be part of the field expenses.

Flight and cargo considerations 2009.

We have planned for 10 LC-130 missions this year. In our cargo schedule we have planned for an average load per flight of 19,000 lbs. It is our hope that with a good skiway and good refuelling possibilities we may negotiate a slightly higher payload with the pilots. However, as the schedule now looks, we have to ask all participants to be aware of the importance of keeping weights low.

Typical specifications for LC-130 and Twin Otter

Actual specs depend on the aircraft used, its equipment, fuel type etc.

De Havilland DHC-6, Twin Otter:

Weight empty [kg]	3456
Max take off weight [kg]	5682
Weight of ski	250
Empty weight with ski	3706
Max load [kg]	1976
Fuel consumption(330l/hr) [kg/hr]	270
Speed without ski(135 kn) [km/hr]	250
Speed with ski (125 kn) [km/hr]	230
Max range [km]	556
Max altitude [ft]	30,000
With pax	10,000
Fuel load [kg]	1100
Loading data:	
Cargo hatch [m]	2.0*1.9
Cargo compartment	
Length, incl rear cabin etc [m]	8.1
Width 1,1m, max	1.2
Hight 1,3m, max	1.4
Pay load	
Normal with full fuel load [kg]	990
Maximum	1260

In order for the cargo to fit through the cargo door, if the cargo is:

- 5.5m long, it must not be more than 0.2m thick
- 4.0m long, it must not be more than 0.35m thick
- 2.5m long, it must not be more than 0.65m thick
- 1.3m long, it must not be more than 0.12m thick

Typical LC-130 specifications:

(all specs for info only, depends on aircraft etc)

An empty LC-130 is [lbs]	91000
Tank capacity:[lbs]	61000
Max touch down weight open snow [lbs]	125000
Max take off weight [lbs]	155000
Max landing weight [lbs]	155000
Max landing weight on prepared skiway [lbs]	135000
Fuel capacity [lbs]	62000
Fuel consumption [lbs/hr]	5000
Nominal speed [kn]	290
Flight time SFJ-NGRIP-SFJ (1020 nm)	4.4 hours
Flight time SFJ-NEEM-SFJ (1260 nm)	5.4 hours
Range with max payload [miles]	2364
Max air hours [h]	10
Cargo room max 41*10.3*9' [m]	12.50*3.14*2.74
Physical door width 116" [m]	2.94
Cargo deck to ceiling 9' 1" [m]	2.76
Max weight for one pallet, pos 1-4 [lbs]	10000
Max weight of one pallet, pos 5 [lbs]	8500
Max weight of ramp pallet [lbs]	4664
Nominal empty weight of pallet and nets [lbs]	355
Max weight multplie pallet for combat offload [lbs]	12000
Pallet outside dimensions 88"*108" [m]	2.23*2.75
Pallet inside dimensions 84"*104"*2.25" [m]	2.13*2.64
Max height normal pallet, 96" [m]	2.44
Normal height of pallet, snow and combat [m]	2.28
Max height ramp pallet for combat offload [m]	1.75
Max height dual or tripple pallet [m]	1.75
Max vol per pallet [m ³]	13.7
Max vol ramp pallet [m ³]	8.75
Width wheel well area 123" [m]	3.12
Width ramp without rails 114" [m]	2.89
Width outboard rails 105 5/8" [m]	2.68
Ramp height 44" to 49" [m]	1.12 to 1.25
Ramp length 10' [m]	3.05
No of pax without using pallet space	4
1 pallet equals [pax]	8
2 pallet equals [pax]	14

Note: Pallet heights are measured from top of pallet.
Max weight for pallet on 931B forks is 2200 lbs

Useful container data

Standard containers

The following table shows the weights and dimensions of the three most common types of containers worldwide. The weights and dimensions quoted below are averages, different manufacture series of the same type of container may vary slightly in actual size and weight.

		20' container		40' container		45' high-cube container	
		imperial	metric	imperial	metric	imperial	metric
external dimensions	length	19' 10½"	6.058 m	40' 0"	12.192 m	45' 0"	13.716 m
	width	8' 0"	2.438 m	8' 0"	2.438 m	8' 0"	2.438 m
	height	8' 6"	2.591 m	8' 6"	2.591 m	9' 6"	2.896 m
interior dimensions	length	18' 10 ⁵ / ₁₆ "	5.758 m	39' 5 ⁴⁵ / ₆₄ "	12.032 m	44' 4"	13.556 m
	width	7' 8 ¹⁹ / ₃₂ "	2.352 m	7' 8 ¹⁹ / ₃₂ "	2.352 m	7' 8 ¹⁹ / ₃₂ "	2.352 m
	height	7' 9 ⁵⁷ / ₆₄ "	2.385 m	7' 9 ⁵⁷ / ₆₄ "	2.385 m	8' 9 ¹⁵ / ₁₆ "	2.698 m
door aperture	width	7' 8 ¹ / ₈ "	2.343 m	7' 8 ¹ / ₈ "	2.343 m	7' 8 ¹ / ₈ "	2.343 m
	height	7' 5 ³ / ₄ "	2.280 m	7' 5 ³ / ₄ "	2.280 m	8' 5 ⁴⁹ / ₆₄ "	2.585 m
volume		1,169 ft ³	33.1 m ³	2,385 ft ³	67.5 m ³	3,040 ft ³	86.1 m ³
maximum gross mass		52,910 lb	24,000 kg	67,200 lb	30,480 kg	67,200 lb	30,480 kg
empty weight		4,850 lb	2,200 kg	8,380 lb	3,800 kg	10,580 lb	4,800 kg
net load		48,060 lb	21,600 kg	58,820 lb	26,500 kg	56,620 lb	25,680 kg

20-ft, "heavy tested" containers are available for heavy goods (e.g. heavy machinery). These containers allow a maximum weight of 67,200 lb (30,480 kg), an empty weight of 5,290 lb (2,400 kg), and a net load of 61,910 lb (28,080 kg).

1 feet = 0.3048 m
 1 lbs = 0.4536 kg
 1 US gallon = 3.7854 l

Max dimension of cabin luggage: 55*40*23 cm, 8 kg
 Density of Jet A1 805 kg/m³
 Density of mogas 720 kg/m³
 200 l drum of JET A1 or D60 178 kg

Empty standard drum 15 kg

Firn density for stop of water flow: 720 kg/m³

CINA equation for the relation between pressure and altitude:

$$p[mb] = p_0 \left(\frac{288 - 6.5 \cdot 10^{-3} \cdot h}{288} \right)^{5.256}$$

where $p_0=1013,25\text{mb}$, 288K standard air temperature at sea level (15°C) and $6.5 \cdot 10^{-3}$ the standard lapse rate in the troposphere [$^\circ\text{C}/\text{m}$]. Use this equation to obtain the sea level pressure when the altitude is known, i.e. for aviation weather reports.

Chill temperature:

This is the formula used for calculating wind-chill-temperatures:

$$t_{Chill} [^\circ\text{C}] = \left(\frac{10.45 + 10\sqrt{v} - v}{22.034} \right) \cdot (t - 33) + 33 [^\circ\text{C}; \text{m} / \text{s}]$$

Current capability of electrical cables:

Area [mm ²]	Resistance [Ohm,/100m]	Nom load [A]	Max load [A]
0,7	2.3	6	10
1,5	1.16	15	25
2,5	0.69	20	35
4,0	0.43	25	45
6,0	0.29	40	60
10	0.175	60	80
16	0.11	80	110
25	0.07	100	135

Connections to 5-conductor cable:

Yellow/green:	Protective ground
Black	L1
Blue	N
Brown	L2
Black	L3

Attenuation of coaxial cables:

RG58/U attenuation per 30m:

10 MHz	1.5 dB at SWR 1.0.	+0.5 dB at SWR = 3
200 MHz	8.0 dB at SWR 1.0.	+1.2 dB at SWR = 3
1500 MHz	30 dB at SWR 1.0	+1.2 dB at SWR = 3

RG213/U attenuation per 30m:

10 MHz	0.7 dB at SWR 1.0	+0.4 dB at SWR = 3
200 Mhz	3.5 dB at SWR 1.0	+1.0 dB at SWR = 3
1500MHz	12 dB at SWR 1.0	+1.2 dB at SWR = 3

HF Radio Yagi-Uda Antenna:

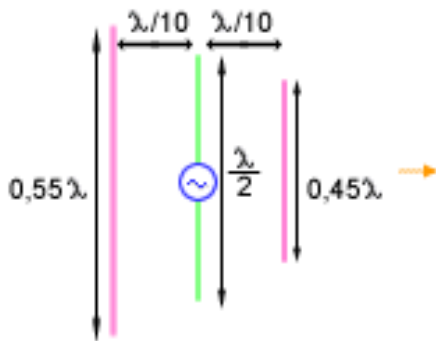

From left to right, the elements mounted on the boom are called,

- Reflector element**
- Driver element**
- Director element**

The reflector is 5% longer than the driver element, and the director 5% shorter.

Typical dimensions for 3 element wide spaced 8093 kHz Yagi-Uda antenna:

Reflector length:	0.5* l	18.53m
Dipole length	0.475* l	17.60m
Director length	0.45* l	16.68m
Distance Reflector-Dipole	0.23* l	8.53m
Distance Dipole-Director	0.25* l	9.27m

With this length of the antenna the gain is expected to 7 dB, SWR<2

Coordination of LC-130 in Kangerlussuaq

Proposal regarding the coordination of CPS/NEEM and 109'th TAG activities in Sonde.

This proposal is written to make the field coordination between CPS/CH2MHill, NEEM and 109'th TAG as smooth and easy as possible by ensuring efficient ways of exchanging first hand information between the responsible Field Operations Managers (FOM's) for CPS and NEEM and 109'th TAG personnel during periods with flights for the GISP and NEEMS programmes.

Copies of this paper should be given to each Deployment Commander and the mission crew should be briefed on the contents before departure to Greenland. This will ensure that the FOM's and the 109'th personnel will operate along the same outlines throughout the field season.

In the following it is assumed that prior to the field activities of CPS and NEEM in Greenland plans and agreements have already been made between CPS/NEEM and 109'th TAG regarding times of deployment in Sonde, expected number of missions throughout the season, total cargo estimates, estimates on cargo straps, nets and pallets needed, ski-way marking, ski-way preparation, off load areas, radio frequencies etc.

Flight period:

After arrival of 109'th to Kangerlussuaq a meeting should be held between 109'th DC, 109'th cargo responsible and the FOM's of CPS and NEEM. Both FOM's need to be there since U.S. NSF activities and NEEM project are financially independent and each FOM carry the financial responsibility regarding 109'th operations. At this meeting the FOM's will provide information on:

- Planned flights,
- Amount of cargo,
- Hazardous cargo,
- Number of PAX to be transported,
- Ski-way conditions in camp,
- Ski-way, taxiway and off-load area outlines relative to the camps,
- Updates on radio frequencies,
- Current weather and
- Communication radio frequencies & phone numbers.

The DC will provide information on the exact duration of the deployment, ground crew availability, aircraft availability and options in case of bad weather. The meeting will result in an operation schedule for the flight period in question. Both FOM's and the DC should consult each other in case of changes in this schedule.

Day to day operations:

The FOM's will normally organize that all cargo is palletized and strapped down. In cases of doubt the FOM's will consult the Aerial Port regarding palletization. The FOM's will always consult the Aerial Port when married pallets are being built and when load vehicle (k-loader) is needed. The FOM's will determine the weight of the pallets. The FOM's will indicate to Aerial Port which pallets are going on

each flight and will indicate the position of any hazardous cargo on the pallets. Normally, transportation of pallets from the staging area to the planes and vice versa will be handled by Aerial Port using the Articulated front loaders or other load vehicles. However, the FOM's will assist in the on- and off-loading of aircraft whenever needed using the NEEM forklifts and trucks.

Cargo manifests, passenger manifests and shippers declarations of hazardous material will be prepared by each FOM office and delivered to Skier operations on the day before departure. In case of last minute changes (e.g. changes in passengers) the changes to the manifests will be passed on to Skier operations no later than two hours before departure. The FOM's will get aviation weather observations from the field camps on a one hour basis, starting at least 2 hours prior to scheduled departure.

Since each FOM is economical responsible to his/her programme, the flight crew will request a clearance to go from the FOM just before brake release prior to take-off. In case the FOM has not been present at plane departure, the flight crew will call the appropriate FOM office (either CPS SONDE or GOC SONDE) by radio HF 8.093 MHz or VHF 122.8 MHz to obtain clearance to go.

During missions 8.093 MHz, Iridium phone and BGAN phone will be monitored for updates on weather and mission progress from plane crews and field camps. NOTE: Both camps and FOM offices will have phone lines open 24 hours a day. The FOM offices will relay information on mission progress to Skier OPS.

End of flight period:

At the end of deployment, before departure of the 109'th to the U.S. or, when there is a change of DC, a meeting should be held between the 109'th and the CPS and NEEM FOM's in order for the FOMs and DC to sign the mission sheet, incl. the number of flight hours assigned to the different programs.

Updated, March 16, 2009 by J.P.Steffensen

AVIATION WEATHER REPORTS

The aviation weather reports should report the following in the sequence shown:

1. Time [local, here Sonde hours], use 24 hour format.
2. Ceiling [100 feet], estimated or observed %, [scattered, broken, overcast]
3. Visibility [nautical miles or fractions their off]
4. Temperature (Celsius). State centigrade.
5. Wind, Direction and Speed. Magnetic direction 10 deg, velocity knots
6. Pressure [milli-bars], reduced to zero elevation using 10700' for GRIP, 10600' for GISP, 9700' for NGRIP, 8140' for NEEM
7. Horizontal definition [good, fair, poor, nil]
8. Surface definition [good, fair, poor, nil]
9. Comments.

Example 1:

0630 local, 2500 feet estimated scattered 60%, 2 miles, -15 degC, Wind 290 mag 12 knots, 1013 milli-bars, good, fair, ski-way clear, fogbank SE of ski-way..

Visibility: Nautical miles or fractions of miles. Any visibility problems less than 6 miles state obscuring phenomenon.

Choices: Haze, snow, ice fog, ground fog, blowing snow, white out. Max visibility stated 25 miles.

Pressure: Local pressure converted to sea level according to international aviation CINA standard atmosphere. State millibars. Note, that the elevation used is the nominal elevation in feet, not the actual elevation.

Horizon definition:	Good: Sharp horizon	Fair: Identifiable
	Poor: Barely discernable	Nil: No horizon

Surface definition

GOOD: Snow surface features are easily identified by shadow. (Sun in obscured)
FAIR: Snow surface can be identified by contrast. No definite shadow exist. (Sun obscured).
POOR: Snow surface cannot be identified except close up. (Sun totally obscured).
NIL: Snow surface features cannot be identified. No shadow or contrast. Dark coloured objects seem to "float" in the air. Glare is equally bright from all directions.

Whiteout NIL surface, NIL horizon

Comments: Plain language comments, trends, changes.
 Fog bank north, Visibility decreasing.
 Winds variable. Barometer rising.

Conversion:	1mB	= 0.0295300 in.Hg.
	1 feet	= 0.3048 meter,
	1 nau.miles	= 1853 meter.
	1 m/s	= 1.943 knots

Communication plan

Typical radio communication plan.

The major part of the communication is performed using BGAN and Iridium satellite communication. However, most flight related communication is performed on the radio.

Site Names: CPS Sonde, Summit radio, NEEM camp, GOC Sonde.

Frequencies:

Primary	8093 kHz	Ice freq. For camp to FOM communication
Secondary	4753 kHz	Ice freq, Best for distances up to 400 km.
	3815 kHz	Optional frequency for local traverse, 3350 may also be used depending on distance and antenna
	4050 khz	Main east Greenland party line frequency.
	5942 khz	Ice freq, backup, intermediate distances
	7995 khz	Ice freq, digital comms.
	11217 kHz	Ground Air back up frequency

All frequencies use SSB, USB

VHF radio.

Camp communication with air craft is performed on Air band 122.8MHz FM.

Schedule:

GOC Sonde will monitor 8093 on a routine basis. Main Sonde-Camp contact time is at 18:45 SFJ hours, but depends on CPS Polarfield Services use of the frequency and the camp activities.

If aircrafts are expected, weather reporting starts 2 hours prior to estimated take off time on a 30 min basis unless otherwise arranged. Reporting primarily on radio with Iridium or BGAN as backup unless agreed otherwise.

Summary of frequencies used in Greenland

Maritime:	1638	Most likely outdated
	2090	
	2182	Call
GGU:	2784	
	3350	Main
	3815	
	4050	Main East Greenland frequency
Aircrafts:	2950	SFJ FIC
	4724	Thule Airways
	5526	SFJ FIC
	6739	Main Aircraft frequency
	8945	SFJ FIC
	8968	Thule Airways
	10042	SFJ FIC
Thule DLO	6756	Danish Liason Officer
Misc.	8891	Iceland Radio
	8924	Iceland Radio, Phone patch
	10030	Iceland Radio, Phone patch
	11270	Iceland Radio
VHF radio.	118.1	CNP AFIS
	118.3	SFJ Approach
	121.3	SFJ FIC
	121.5	Call, Emergency
	122.8	Air to ground
	126.2	SFJ Tower
BBC:	21710, 15070, 12095, 9410, 7325, 6180, 5975	
VOA:	16430, 11805, 9760, 6095	
DK:	13800,11840,9590,9485,7520,7465	

Phonetic alphabet

A special way of saying letters and numbers that makes them less likely to be misunderstood when they are transmitted over radios.

A	Alpha	N	November	1	Wun
B	Bravo	O	Oscar	2	Too
C	Charley	P	Papa	3	Tree
D	Delta	Q	Quebec	4	Fower
E	Echo	R	Romeo	5	Fiwer
F	Foxtrot	S	Sierra	6	Six
G	Golf	T	Tango	7	Seven
H	Hotel	U	Uniform	8	Aight
I	India	V	Victor	9	Niner
J	Juliet	W	Whiskey	0	Zeeroh
K	Kilo	X	Xray		
L	Lima	Y	Yankee		
M	Mike	Z	Zulu		

In addition, numbers are usually spoken as individual digits. For example, 123 would be read as “wun too tree”.

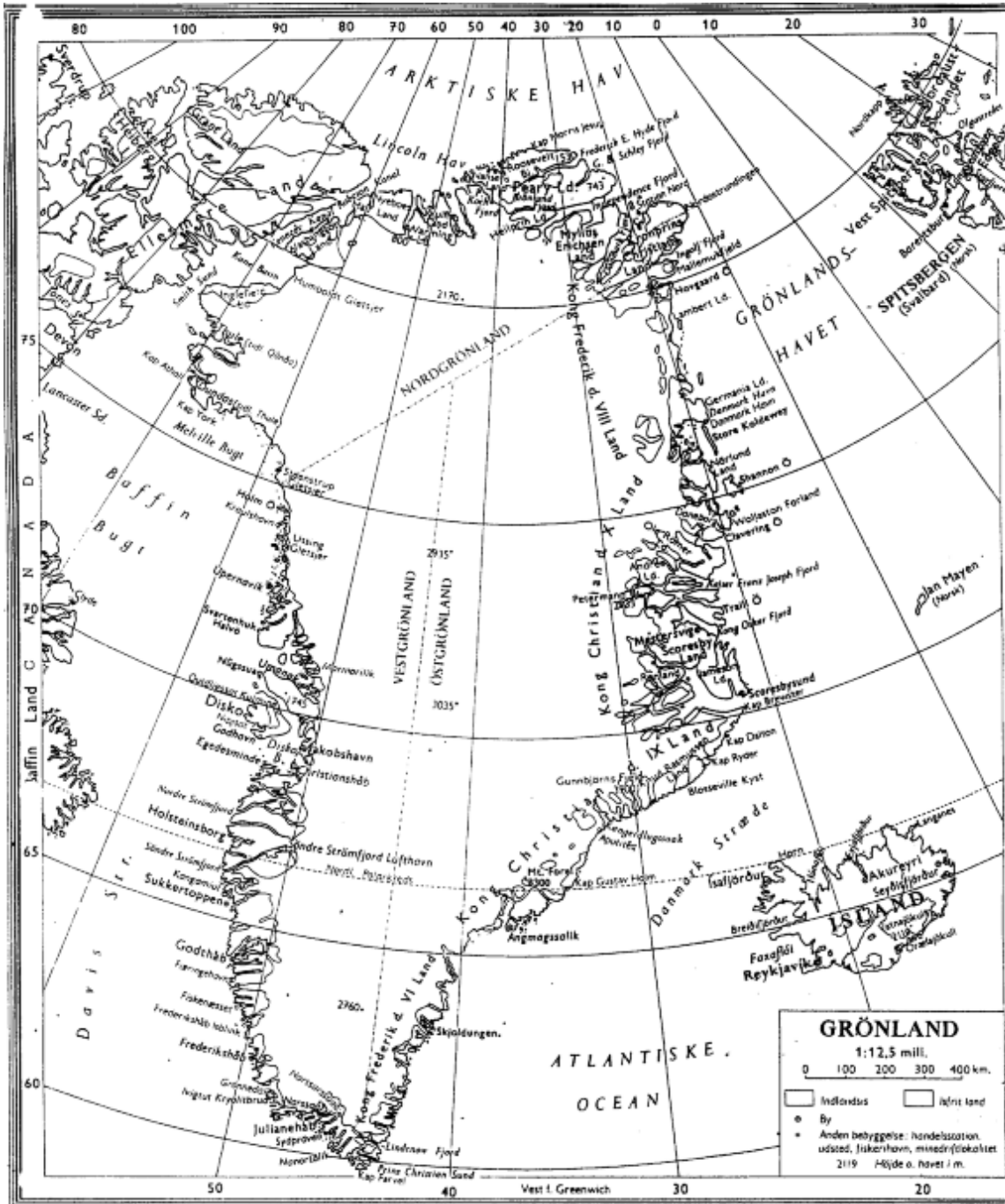

Positions in Greenland

Positions in Greenland				
Site	N, deg	W, deg	N, deg, min	W, deg,min
Aasiaat, BGAA	68,7219	52,7847	68 43 19	52 47 05
AEY	65,65	18		
AWI 1995 depot	76,63	46,37	76 38	46 22
Camp Century, tower	77,1797	61,10975	77 10 46	61 06 35
Camp Century,upstream	77,22122	60,80012	77 13 16	60 48 00
CNP, BGCO	70,7417	22,6583	70 44 30	22 39 30
DMH	76,79	18,65		
Dye-2	66,485	46,298	66 29 06	46 17 54
Dye-3	65,15139	43,81722	65 09.05	43 49.02
GISP (Summit)	72,58833	38,4575	72 34.78	38 27.27
GRIP	72,58722	37,64222	72 34.74	37 37.92
HT, 95 Drill site	82,50556	37,47222	82 29.8	37 28.2
JAV, BGJN	69,2444	51,0622	69 14 40	51 03 44
Kangerlussuaq, BGSF	67,0111	50,725	67 00 40	50 43 30
Kulusuk, BGKK	65,5736	37,1236	65 34 25	37 07 25
Longyearbyen	78,25	15,5		
Narsarsuaq,BGBW	61,1611	45,42780	61 09 40	45 25 40
NEEM	77.4486	51.0556	77 26 54.93	51 03 19.89
NGRIP	75,1	42,30000	75 06	42 20
NGT23, B20	78,83333	36,50000	78 50 00.0	36 30 00.0
NGT27, B21	79,99925	41,13744	79 59 57.3	41 08 14.8
NGT30, B22	79,34142	45,91156	79 20 29.1	45 54 41.6
NGT33, B23	78,00000	44,00000	78 00 00.0	44 00 00.0
NGT37	77,25000	49,21667	77 15	49 13
NGT39	76,65000	46,48333	76 39	46 29
NGT42	76,00000	43,50000	76 00	43 30
NGT45	75,00000	42,00000	75 00	42 00
Nuuk, BGGH	64,1944	51,6806	64 11 40	51 40 50
Saddle North	66,43333	43,33333	66 26	43 20
STANOR	81,6	16,650	81 36	16 39
Storstrømmen			77	22
T53. JJ			71 21.24	33 27.34
T61	72,2	32,3	72 12	32 18
Thule AB	76,53	68,7	76 32 00	68 42 00
Uummannaq, BGUQ	70,7342	52,6961	70 44 03	52 41 46

Relevant distances and directions

Relevant distances and directions				
From	To	km	dir	dir
AEY	NOR	1780		
AEY	CNP	600		
CNP	THU	1532	315	90
CNP	DMH	686		
CNP	GRIP	561	298	104
DMH	NGT33	627	294	89
DMH	NOR	539		
GRIP	DMH	670	35	231
GRIP	NOR	1120	17	218
GRIP	JJ	198	131	315
HT	NGT23	410	177	358
JAV	THU	994	333	136
JAV	GRIP	618	46	239
NEEM	SFJ	1180		
NEEM	THU	480		
NEEM	UPERNAVIK	600		
NEEM	NGRIP	365		
NGRIP	CNP	799	117	316
NGRIP	GRIP	315	150	335
NOR	Longyearb	717		
NOR	HT	335		
SFJ	THU	1224	338	141
SFJ	JAV	245	356	176
SFJ	NOR	1861	17	23
SFJ	GRIP	796	33	225
THU	CC	205		
THU	HT	887	29	239
THU	NGT33	625		
THU	GRIP	1005	101	310
THU	NOR	1182		

NEEM Steering Committee

Name	Address	E-mail
Dorte Dahl-Jensen Christine S. Hvidberg Henrik B. Clausen Jørgen Peder Steffensen Sune Olander Rasmussen Susanne Lilja Buchardt Simon G. Sheldon Lars Berg Larsen Steffen Bo Hansen Thomas Blunier	Niels Bohr Institute Juliane Maries Vej 30 DK-2100 Copenhagen Ø Denmark	ddj@gfy.ku.dk ch@gfy.ku.dk hbc@gfy.ku.dk jps@gfy.ku.dk olander@gfy.ku.dk lilja@gfy.ku.dk Sheldon@gfy.ku.dk lbl@gfy.ku.dk sbh@gfy.ku.dk blunier@gfy.ku.dk
Jocelyne Bourgeois	Geological Survey of Canada Natural Resources Canada 601 Booth St. Ottawa, ON K1A OE8 Canada	jcbourge@nrcan.gc.ca
Thomas Röckmann Roderik Van de Wal	IMAU Princetonplein 5 Utrecht University 3584CC Utrecht The Netherlands	t.roeckmann@phys.uu.nl wal@phys.uu.nl
Frank Pattyn	Laboratoire de Glaciologie Université Libre de Bruxelles CF 160/03 Av. F. Roosevelt 50 B-1050 Brussels Belgium	fpattyn@ulb.ac.be
Heinz Miller Sepp Kipfstuhl Daniel Steinhage	Alfred-Wegener-Institute Columbusstrasse 27568 Bremerhaven Germany	Heinrich.Miller@awi.de kipfstuhl@awi-bremerhaven.de daniel.steinhage@awi.de
Jim White	INSTAAR University of Colorado Boulder, Colorado 80309	James.White@colorado.edu

USA

Soon Do Hur Sungmin Hong	Korea Polar Research Institute Song do Technopark In Cheon 406-840 Korea	sdhur@kopri.re.kr smhong@kopri.re.kr
Jiawen Ren	Cold & Arid Regions Res. Inst. Chinese Academy of Sciences Lanzhou, Gansu 730000 China	Jwren@lzb.ac.cn
Margareta Hansson	Department of Physical Geography and Quaternary Geology Stockholm University S-10691 Stockholm Sweden	margareta.hansson@natgeo.su.se
Prasad Gogineni Claude M. Laird	CreSIS The University of Kansas 2335 Irving Hill Rd Lawrence, KS 66045 USA	gogineni@crisis.ku.edu claird@ku.edu
Robert Mulvaney	British Antarctic Survey High Cross Madingley Road Cambridge CB3 0ET UK	rmu@bas.ac.uk
Siman Davies	Uwch Ddarlithydd Adran Daearyddiaeth Ysgol yr Amgylchedd a Chymdeithas Prifysgol Abertawe Parc Singleton, Abertawe SA2 8PP, Cymru	Siwan.Davies@swansea.ac.uk
Valérie Masson-Delmotte	LSCE Bat 701 L'Orme des Merisiers CEA Saclay 91191 Gif s/Yvette Cedex France	valerie-masson@cea.fr

Jakob Schwander
Thomas Stocker

University Bern
Climate and Environmental
Physics
Sidlerstrasse 5
CH-3012 Bern
Switzerland

schwander@climate.unibe.ch
stocker@climate.unibe.ch

Kumiko Goto-Azuma
Yoshiyuki Fujii

National Institute of Polar
Research
10-3 Midori-cho , Tachikawa
Tokyo 190-8518
JAPAN

kumiko@nipr.ac.jp
fujii@nipr.ac.jp

Arny Sveinbjörnsdottir

Institute of Earth Sciences
University of Iceland
Sturlugata 7
IS-107 Reykjavik
Iceland

arny@hi.is

NEEM 2010 Participant Address List

Email list participants:

Abbott, Peter	Peter.Abbott@st-andrews.ac.uk
Abram, Nerilie	nabr@bas.ac.uk
Albershardt, Louise	loumark@digisys.net
Aleman, Olivier	alemany@lgge.obs.ujf-grenoble.fr
Andersen, Torben	duckson@gmail.com
Andres, Heather	handres@physics.utoronto.ca
Arntorsson, Gunnar Magnus	gma@hekla.is
Azuma, Kumiko	kumiko@nipr.ac.jp
Balslev-Clausen, David	dbc@nbi.ku.dk
Larsen, Lars Berg	lbl@gfy.ku.dk
Berggren, Anne marie	ann-marie.berggren@geo.uu.se
Bigler, Matthias	bigler@climate.unibe.ch
Bjerregaard Simonsen, Sebastian	sbs@nbi.ku.dk
Blunier, Thomas	blunier@gfy.ku.dk
Bourgeois, Jocelyne	jcbourge@NRCan.gc.ca
Brand, Tina Blumensaadt	tbbrand@snm.ku.dk
Burton, Timothy	southpolartim@yahoo.co.uk
Chappellaz, Jérôme	chappellaz@lgge.obs.ujf-grenoble.fr
Hvidberg, Christine	ch@gfy.ku.dk
Chung, JiWoong	jjw79@kopri.re.kr
Curran, Mark	Mark.Curran@utas.edu.au
Dahl-Jensen, Dorthe	ddj@gfy.ku.dk
Dallmayr, Remi	dallmayr@lgge.obs.ujf-grenoble.fr
Valero Delgado, Fernando	Fernando.Valero@awi.de
Dummermuth, Angelika	Angelika.Dummermuth@awi.de
Duphil, Romain	Romain.Duphil@lgge.obs.ujf-grenoble.fr
Elliott, Elizabeth	drlizzie@gmail.com
Falourd, Sonia	sonia.falourd@cea.fr
Florian, Hans Christian	hcflorian@hotmail.com
Gfeller, Gideon	gideongfeller@gmail.com
Gkinis, Vasileios	v.gkinis@gfy.ku.dk
Grindsted, Aslak	aslak@gfy.ku.dk
Hansen, Steffen Bo	sbh@gfy.ku.dk
Hansson, Margareta	margareta.hansson@natgeo.su.se
Harvey, Sarah	sarahh75@hotmail.com
Hilmarsson, Sverrir Æ.	shilmars@simnet.is
Holm Hansen, Lone	lone@nbi.dk
Hubbard, Bryn	byh@aber.ac.uk
Hviid, Rene	Hviids@gmail.com

Hwang, Heejin	heejin@kopri.re.kr
Jenk, Theo	jenk@gfy.ku.dk
Johnsen, Sigfus Johann	sigfus@gfy.ku.dk
Jønch Andersen, Jeppe	jja@astro.ku.dk
Uhl-Jensen, Simon	simonuhl@hotmail.com
Jouzel, Jean	Jean.jouzel@lsce.ipsl.fr
Karlin, Anders Torbjörn	torbjorn.karlin@natgeo.su.se
Kawamura, Kenjii	kawamura@nipr.ac.jp
Kettner, Ernesto	e.kettner@gfy.ku.dk
Kipfstuhl, Sepp	kipfstuhl@awi.de
Kjær, Helle Astrid	hellek@fys.ku.dk
Kjærgaard, Marie	marianguaq@gmail.com
Köhler, Peter	Peter.Koehler@awi.de
Kuhl, Tanner	tanner.kuhl@ssec.wisc.edu
Läpple, Thomas	Thomas.Laepple@awi.de
Leonhardt, Martin	Martin.Leonhardt@awi.de
Petersen, Anne Wang	annewang@fys.ku.dk
Leuenberger, Daiana	dleuenberger@climate.unibe.ch
Mandeno, Darcy Roberts	Darcy.Mandeno@vuw.ac.nz
McConnel, Joe	Joe.McConnell@dri.edu
Mulvaney, Robert	rmu@bas.ac.uk
Panton, Christian	panton@gfy.ku.dk
Pasteris, Daniel	pasteris@dri.edu
Popp, Trevor	popp@gfy.ku.dk
Pyne, Alex	Alex.Pyne@vuw.ac.nz
Ravneberg, Louise Wolff	ravneberg@hotmail.com
Reutenauer, Corentin	creuten@nbi.ku.dk
Rosen, Julia	julia.rosen@gmail.com
Rufli, Henry	rufli@climate.unibe.ch H.Rufli@gmx.ch
Samyn, Denis	denis.samyn@geo.uu.se
Sapart, Célia	c.j.sapart@uu.nl
Sato, Motoyuki	siempregracias@gmail.com
Schilt, Adrian	schilt@climate.unibe.ch
Schmidt, Astrid	ASchmidt@snm.ku.dk
Schmidt, Kerstin	Kerstin.Schmidt@awi.de
Schüpbach, Simon	schuepbach@climate.unibe.ch
Schwander, Jakob	schwander@climate.unibe.ch
Severinghaus, Jeff	jseveringhaus@ucsd.edu
Sheldon, Simon	sheldon@gfy.ku.dk
Skaarup, Gertie	skaarup@nbi.dk
Skrydstrup, Martin	martin.skrydstrup@anthro.ku.dk
Sørensen, Majbritt W.	majbritt@fys.ku.dk
Sowers, Todd	todd.sowers5@gmail.com
Steen-Larsen, H.C.	hanschr@gfy.ku.dk

Steffensen, Jørgen Peder	jps@gfy.ku.dk
Stowasser, Christopher	chrisstowasser@gmail.com
Svavarsson, Adalsteinn	allismidur@internet.is
Svensson, Anders M.	as@gfy.ku.dk
Teste, Gregory	teste@lgge.obs.ujf-grenoble.fr
Thing, Henning	thing@gfy.ku.dk
Thomas, Liz	lith@bas.ac.uk
Tison, Jean-Louis	jtison@ulb.ac.be
Triest, Jack	jtri@bas.ac.uk
Twarloh, Birthe	Birthe.Twarloh@awi.de
Uetake, Jun	juetake@nipr.ac.jp
Van der Veen, Carina	C.vanderVeen@phys.uu.nl
Vallelonga, Paul	ptravis@nbi.ku.dk
Van der Well, Gerko	vanderwel@climate.unibe.ch
Vinther, Bo	bo@gfy.ku.dk
Wang Shimeng	wangshimeng@lzb.ac.cn
Wegner, Anna	anna.wegner@awi.de
Weikusat, Ilka	Ilka.Weikusat@awi.de
White, Jim	James.White@Colorado.EDU
Zabori, Julia	julia.zabori@itm.su.se
Zhang, Thong	mgrdsyzs@gmail.com
Zheng, James	jzeng@nrcan.gc.ca

NYANG +299 84 13 89
 Met Office tel.: +299 84 10 22
 e-mail:

 FIC: telephone: +299 84 10 34
 Notam +299 84 10 35
 com +299 84 10 24

 KISS: +299 84 13 00
 +299 84 14 87
 +299 84 11 07
 fax: +299 84 14 72
 email sciencesupport@glv.gl

Summit camp

Iridium sat. Tel.: +8816 314 59738
 Inmarsat Std. C 584 49 3139145
 HF radio on 8093 MHz (Summit Camp, daily at 08:45)

Danish Space Center

Rene Forsberg
 Iridium sat. tel: +8816 314 26400
 Mobile: +45 25 40 27 75

Alert

Telephone: +1 613 946 0146 ext. 3393 (primary),
 +1 613 996 7811 (secondary)

Thule

Liason Officer (Forbindelsesofficer) at Thule Air Base (DLO; Tommy Toft, Lars Iversen)
 Office: +299 97 65 26
 Fax: +299 97 67 26
 Mobile: +299 59 41 26
 Email: fotab@greenet.gl
 Telex 0503 91721

Base Operations Dispatch 2717
 Weather Forecaster 2395
 Fuels Management 2553
 Taxi (free) 2022
 Telephone Information 113

Base Operator	0
Danish Spedition, Fax	+299 97 65 74
Danish Spedition, phone	+299 97 66 69, mobile 58 54 09
Danish Spedition, Email	pifuffik@greenet.gl
North Star Inn	+299 97 68 71?
	+299 97 66 36, ext 50606 or 3276
DK Police	+299 97 65 22
DK Police, fax	+299 97 65 00

Ilulissat Airport

Tel.	+299 94 41 40
Fax	+299 94 40 08

Station Nord

Iridium sat. tel.:	+8816 314 10427
Inmarsat Std. C	581 49 2900091
E-mail:	stnord@glk.gl

(via liason officer at Thule Air base, e-mails will be forwarded to Inmarsat Standard –C satellite telex unit at Station Nord).

Flyvestation Aalborg

John Lau Hansen ,RDAF Greenland coordinator,
Thisted landevej 53, 9430 Vadum

Telephone:	+45 98 19 56 76
Mobile:	+45 24 27 33 34
Fax:	+45 98 19 56 96
E-mail:	GLKOORD@mil.dk

Speditøren at Flyvestation Aalborg, Bjarne Sørensen,	
telephone:	+45 98 19 64 10,
FAX:	+45 98 19 64 91

SAS Hotline	+45 3232 6800
-------------	---------------

MEDICAL

Rigshospitalet

(Phone +45 3545 3545)

Mette Siemsen

Phone +45 3545 8018

mette.siemsen@rh.regionh.dk

Cell +45 6128 1107

Private +45 3940 3107

Mette Brimnes Damholt

Phone +45 3545 0589

damholt@dadlnet.dk

Cell +45 2465 5006

Marianne Benn

Phone +45 44883842

marben21@heh.regionh.dk

Private +45 3927 0045

Sun glasses

It is recommended to use sunglasses with UV-protection (Polaroid) to protect eyes from excessive ultraviolet radiation, primarily to avoid snow-blindness, but also to reduce long-term ocular damage such as cataracts. Be careful to wear glasses that also block the sunrays around the edges of the lenses.

Standards for sunglasses – see labelling on inside of the frame

Europe CE (EN 1836:2005)

0	insufficient UV protection
1	sufficient UV protection
2	good UV protection
3	full UV protection

US (ANSI Z80.3-1972)

A compliant lens should have a UVB (280 to 315nm) transmittance of no more than one per cent and a UVA (315 to 380nm) transmittance of no more than 0.5 times of the visual light transmittance.

Australia (AS 1067)

0	some UV protection
1	.
2	.
3	.
4	high level of UV protection

Acute mountain sickness - AMS

Symptoms/signs of acute mountain sickness:

- Headache
- Fatigue/nausea
- Difficulty in breathing
- Sleep disturbances (insomnia)

Symptoms of AMS usually start 6 to 8 hours after a rapid ascent and reach their greatest severity within 24 hours, subsiding over 72 hours. Rapid ascent, exercise, and continuing to ascent to higher altitudes greatly increases the chances of suffering from AMS and its symptoms.

Best way to reduce risk of AMS is to **avoid excessive alcohol consumption the night before flying into camp** and to keep well hydrated on water.

AMS is rarely serious and is usually self-limiting, but may lead to more serious high altitude cerebral edema or high altitude pulmonary edema.

How to operate the Gamow bag

The purpose of the Gamow bag is to provide temporary first aid treatment to victims suffering from varying degrees of acute mountain sickness (AMS) on location and on an emergency basis.

1. Place victim inside bag.
2. Pull the zipper close.
3. Pump the foot operated air pump to begin inflation.
4. Check to make sure that the nylon web retaining straps are not twisted and that they are in their proper locations
5. Inflate the Gamow bag to the desired pressure – see below.
6. A pump per minute rate of 10 to 20 must be maintained at all times to ensure adequate victim protection from excessive carbon dioxide concentrations. An electric oil free air-compressor with an output of at least 1 cubic foot per minute (cfm) may be used to presurize the Gamow bag (use chrome inlet).
7. Do not connect the bag to oxygen.

Ambient conditions			Inside Gamow bag when pressurized to 2 psi (103 mmHg)		
Meters	Feet	mmHg	Meters	Feet	mmHg
2400	7874	562	1054	3458	665
2700	8859	541	1310	4298	645
3000	9843	522	1555	5102	626
3300	10827	503	1805	5922	607
3600	11812	484	2053	6736	588

The Gamow bag should only be used on a temporary or emergency basis. The bag is not intended as a cure for AMS.

Treatment with oxygen greatly outweighs the use of the Gamow bag, but must be maintained at a flow of 6-8 liters per minutes.

How to monitor blood pressure using the Omron electronic monitor

1. The subject sits down and rests their arm on a table so the brachial artery is level with the heart. Alternatively lie on your back and rest the arm across your stomach. This is important when monitoring blood pressure, as pressure is proportional to height. For example, if one measures the blood pressure at head height, the systolic/diastolic pressure readings will be

approximately 35mmHg less compared to readings taken at heart level, whereas at ground height the pressure readings will be 100mmHg greater.

2. Wrap the sphygmomanometer cuff around the upper arm, just above the elbow. Place the tubings on the hollow of your elbow.
3. Press the **ON** button.
4. Press **START**.
5. The blood pressure monitor will automatically measure the blood pressure.
6. **NOTE:** Do not move the arm during monitoring.
7. Monitor displays the systolic blood pressure (the high value) and diastolic blood pressure (the low value) and heart rate.

Blood pressure	Interpretation	Action
SBT>180 mmHg or DBT>110 mmHG	Severe hypertension	Repeat the test; Contact physician
SBT>160 mmHg or DBT>100 mmHG	Moderate hypertension	Repeat the test; Contact physician
SBT>140 mmHg or DBT>90 mmHG	Mild/borderline	
SBT≈120 mmHg and DBT≈80 mmHG	Optimal	
SBT<90 mmHg and DBT<60 mmHG	Hypotension	

SBP= Systolic blood pressure

DBP= Diastolic blood pressure

How to monitor blood glucose

1. Wash your hands.
2. Prepare your lancing device.
3. Remove the test strip from its foil packet.
4. Insert the three black lines at the end of the test strip into the strip port.
5. Push the test strip in until it stops. The monitor turns on automatically.
6. Wait until the monitor displays the "Apply Blood message", which tells you that the monitor is ready for you to apply blood to the blood glucose test strip.
7. Use your lancing device to obtain a blood drop either from a finger or an ear lobe.
8. Before you obtain a blood sample from the fingertip or ear lobe, make sure the sample site is clean, dry, and warm. Avoid squeezing the puncture site.
9. Apply the blood sample to the test strip immediately.
10. Touch the blood drop to the white area at the end of the test strip. The blood is drawn into the test strip.
11. If the monitor shuts off before you apply blood to the test strip, remove the test strip from the monitor and try again.

12. Continue to touch the blood drop to the end of the test strip until the monitor begins the test. The monitor begins the test when you hear the beeper and/or the display window shows the status bar.
13. Then the display window shows the countdown. **Note: Do not** remove the test strip from the monitor or disturb the test strip during the countdown.

Result of blood glucose monitoring

Blood glucose	Interpretation	Action
LO = low (<1.1 mmol/L or 20 mg/dL)	Extremely low	Repeat the test; Contact physician
<2.8 mmol/L (50 mg/dL)	Moderately low	Repeat the test; Contact physician
4.1-5.9 mmol/L (74-106 mg/dL)	Normal	
>11 mmol/L (200 mg/dL)	Moderately high	Repeat the test; Contact physician
HI = High (>27.8 mmol/L or 500 mf/dL)	Extremely high	Repeat the test; Contact physician

Error messages:

Error no 105 or 705: take out batteries, wait five seconds, insert batteries, and try again.

Calibration of new test strip lot:

Insert calibration strip into strip port. Wait until the monitor displays the lot number. Check number against packet.

Automated External Defibrillator (AED)

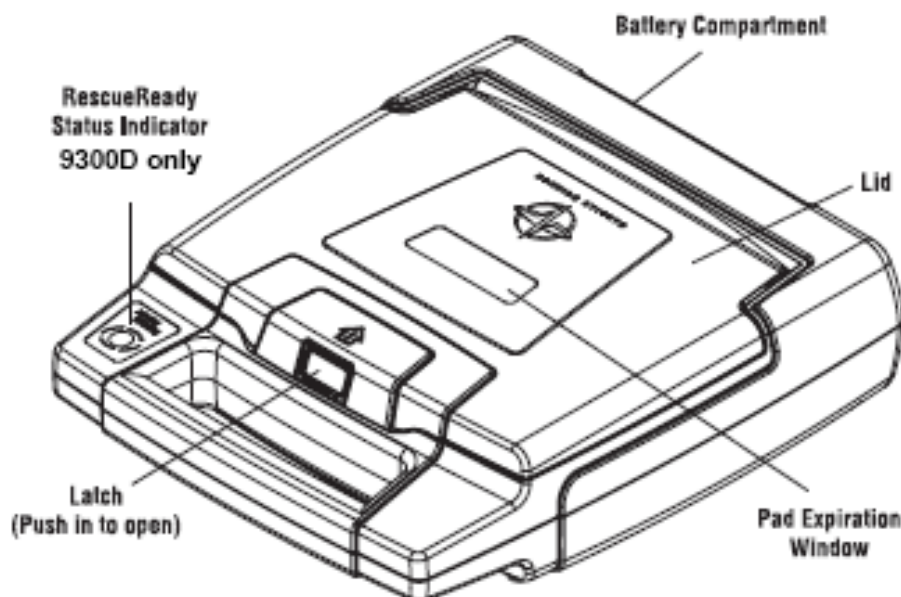

CARDIAC SCIENCE AEDs**STEP 1: ASSESSMENT AND PAD PLACEMENT****PREPARATION**

Determine that the patient is over 8 years of age or weighs more than 55 pounds (25 kg) and exhibits the following:

The patient is unresponsive, and
the patient is not breathing.

Remove clothing from the patient's chest. Ensure the skin site is clean and dry. Dry the patient's chest and shave excessive hair if necessary.

Open the AED lid and wait until the LEDs are lit.



Note: When the patient is a child under 8 years of age or weighs less than 55 lbs (25kg), the AED should be used with the Model 9730 Pediatric Attenuated Defibrillation Pads. Therapy should not be delayed to determine the patient's exact age or weight. See the directions for use accompanying pediatric pads for procedure on changing adult pads to pediatric.

PLACE PADS

The AED will issue the prompt *"Tear Open Package and Remove Pads"* Keep the pads connected to the AED, tear the pad package along the dotted line and remove the pads from the package. Leave the package attached to the pad wires.



After the prompt *"Peel One Pad From Plastic Liner,"* with a firm, steady pull, carefully peel one pad away from the plastic liner.



Then, after the prompt *"Place One Pad on Bare Upper Chest,"* place the pad with the sticky side of on the patient's skin on the upper right chest, placing the top of the pad on the collarbone. Avoid placing the pad directly over the sternum.

Finally, after the prompt *"Peel Second Pad and Place on Bare Lower Chest As Shown,"* pull the second pad from the plastic liner and place it on the lower left chest, below and left of the breast.



Note: Cardiac Science's standard defibrillation pads are non-polarized and can be placed in either position as shown on the pad package.

When the pads are placed, the voice prompt will say *“Do not touch patient. Analyzing Rhythm.”* If the pads are not properly placed or become disconnected at any time during the rescue, the voice prompt *“Check Pads”* will be heard. When this occurs, ensure that:

- Pads are firmly placed on clean, dry skin
- Pad cable is securely plugged into the AED

STEP 2: ECG ANALYSIS

As soon as the AED detects proper pad placement, the voice prompt *“Do Not Touch Patient. Analyzing Rhythm”* will be heard. The AED will begin to analyze the cardiac rhythm of the patient.

If a shock is advised, the voice prompt will say, *“Shock Advised. Charging.”*

When the AED is charged, it continues to analyze the patient’s heart rhythm. If the rhythm changes and a shock is no longer needed, the AED will issue the prompt *“Rhythm Changed. Shock Cancelled,”* disarm and initiate CPR.

If no shock is advised, the AED will prompt to start CPR.

If noise is detected during analysis, the AED will warn you with the prompt *“Analysis Interrupted. Stop Patient Motion”* and restart the analysis. This usually occurs if the patient is excessively jostled or there is a strong electromagnetic emitting electronic device nearby (within 5 meters). Remove the electronic device or stop the excessive motion when you hear this prompt.

STEP 3: SHOCK DELIVERY AND CPR MODE

When the AED is ready to deliver a defibrillation shock, the **SHOCK** button will flash and the prompt *“Stand Clear. Push Flashing Button to Deliver Shock”* will be heard.

Make sure no one is touching the patient and push the **SHOCK** button to deliver a defibrillation shock. (If you do not push the **SHOCK** button within 30 seconds of hearing the prompt, the AED will advise, *“It is now safe to touch the patient. Start CPR.”*)

After the AED delivers the defibrillation shock, the voice prompt will say, *“Shock Delivered.”* The AED will then prompt you to start CPR.



Note: During a rescue, the text screen displays voice prompts, elapsed time of rescue and number of shocks delivered, (for 9300D only).

CPR MODE



After shock delivery or detection of a non-shockable rhythm, the AED automatically enters CPR mode. The voice prompt *“Start CPR”* will be heard.

During the CPR time-out, the AED will not interrupt the CPR mode if the patient’s condition changes and the AED detects a shockable rhythm. After the CPR time-out period has expired, the voice prompt *“Do Not Touch Patient. Analyzing Rhythm.”* will be heard.



Note: During CPR mode, the text screen displays a countdown timer, (for 9300D only).

If the patient is conscious and breathing normally, leave the pads on the patient’s chest connected to the AED. Make the patient as comfortable as possible and wait for Advanced Life Support [ALS] personnel to arrive. Continue to follow the voice prompts until the ALS personnel arrive, or proceed as recommended by the Medical Director.

STEP 4: POST RESCUE

After transferring the patient to ALS personnel, prepare the AED for the next rescue:



1. Retrieve the rescue data stored in the internal memory of the AED by using RescueLink software installed on a PC (see detailed procedure in the Data Management section).
2. Connect a new pair of pads to the AED.
3. Close the lid.
4. Verify that the **STATUS INDICATOR** on the handle is **GREEN**. (For 9300D only)